



Install Guide

Version 1.01

DWL-3200AP

Managed Wireless Access Point

System Requirements:

Minimum System Requirements:

- CD-ROM Drive
- Computers with Windows, Macintosh, or Linux-based operating systems
- Installed Ethernet Adapter Internet Explorer version 6.0 or Netscape Navigator version 7.0 and above

Package Contents



D-Link *AirPremier*™ DWL-3200AP Managed Wireless Access Point



Power Cord



Power over Ethernet base unit



Ethernet Cable



CD-ROM with Manual



Mounting Plate



Power Adapter-DC 48V, 0.4A



Using a power adapter with a different voltage rating will damage and void the warranty of this product.

Installing the Hardware

Step 1

Connect one end of an Ethernet cable (included with your package) to the LAN port on the DWL-3200AP and the other end of the Ethernet cable to the port labeled P+DATA OUT on the PoE base unit.

Step 2

Connect another Ethernet cable from the DATA IN port on the PoE base unit to your router/switch or to a PC.

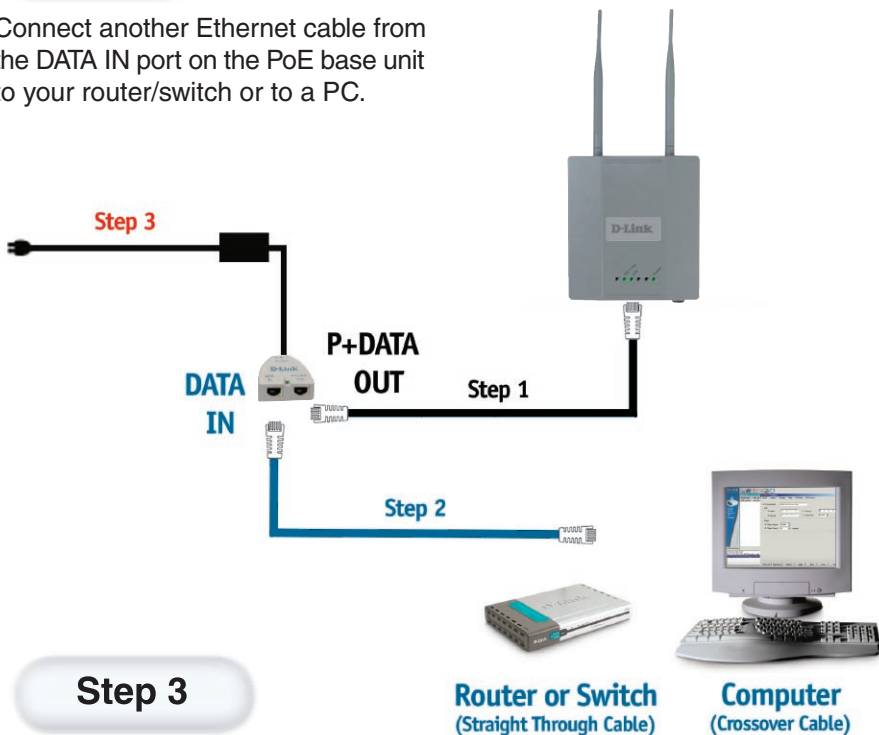

Step 3

Attach the power adapter to the connector labeled POWER IN on the PoE base unit. Attach the power cord to the power adapter and into an electrical outlet.

Using the Setup Wizard

Open your Web browser

and type `http://192.168.0.50` into the URL address box. Then press the Enter or Return key.

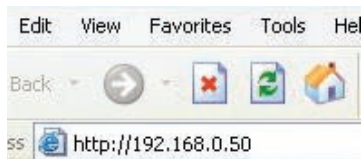

The logon pop-up screen will appear.

Type admin

for the username and leave the password field blank.



Once you have logged in, the **Home** screen will appear.

Click Run Wizard

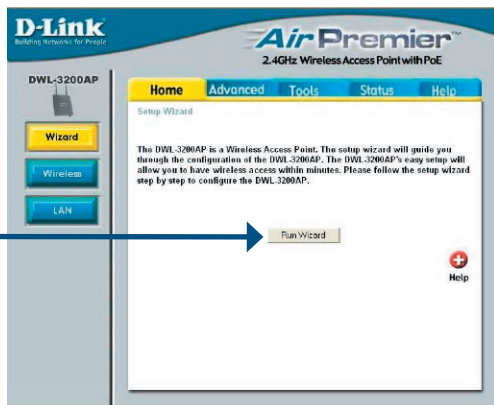

You will see the following screens.

Click Next



Step 1 - Setup your new password. You have the option to establish a password.

Click Next

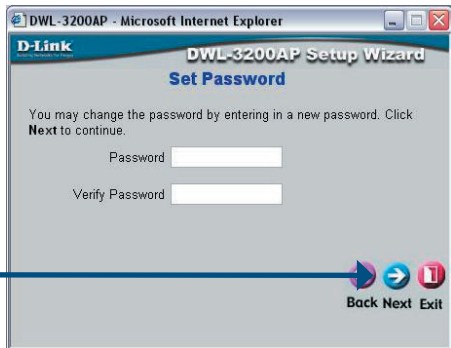

For **802.11g** networks please do the following:

Step 2 - Set Wireless LAN Connection.

By default the DWL-3200AP **SSID** is set to **default** with a **Channel** setting of **6**.

Click Next



For **802.11g** networks please continue as follows:

Step 3 - Encryption

The DWL-3200AP is capable of three levels of wireless encryption: 64-, 128-, 152-bit, using either Hexadecimal or ASCII key type. By default encryption is disabled. You can change the encryption settings for more secure wireless communication.

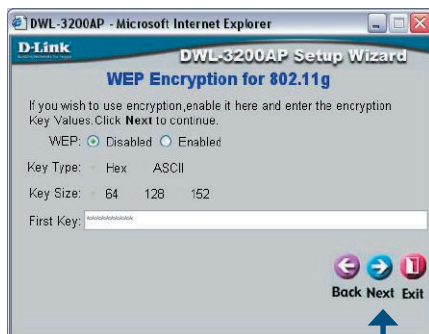

Click Next

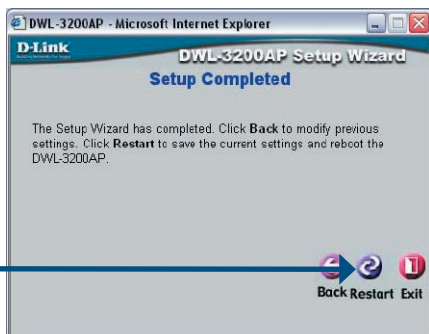

Click Restart

Your Setup is complete!

Your Setup is Complete!

When you have completed the steps in this Quick Installation Guide, your connected network should look similar to this:

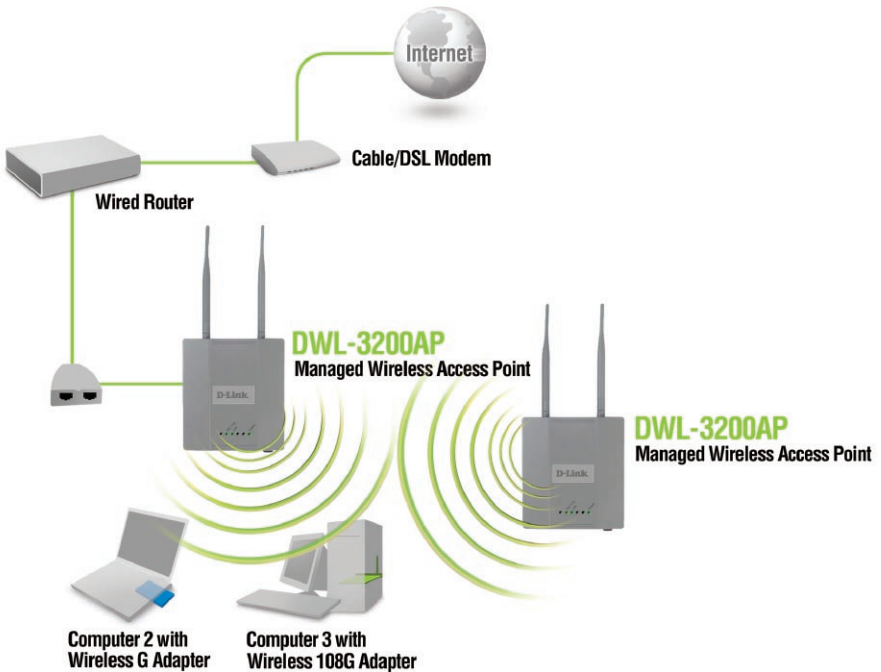

Technical Support

D-Link's website contains the latest user documentation and software updates for D-Link products.

D-Link provides free technical support for customers within the United States and Canada for the duration of the product's warranty period.

U.S. and Canadian customers can contact D-Link Technical Support through our website or by phone.

United States

Telephone

(877) 453-5465

Monday to Friday 6:00am - 6:00pm

World Wide Web

<http://support.dlink.com>

E-mail

support@dlink.com

Canada

Telephone

(800) 361-5265

Monday through Friday, 7:30am to 12:00am EST.

World Wide Web

<http://support.dlink.ca>

E-mail

support@dlink.ca



Version 1.0

Revised 01/21/05

©2004 D-Link Systems, Inc. All rights reserved. Trademarks are the property of their respective holders. Software and specifications subject to change without notice.