



Configuration examples for the D-Link NetDefend Firewall series

DFL-210/800/1600/2500

Scenario: Virtual private network using a PPTP (or L2TP) lan-to-lan tunnel

Last update: 2005-10-20

Overview

In this document, the notation *Objects->Address book* means that in the tree on the left side of the screen **Objects** first should be clicked (expanded) and then **Address Book**.

Most of the examples in this document are adapted for the DFL-800. The same settings can easily be used for all other models in the series. The only difference is the names of the interfaces. Since the DFL-1600 and DFL-2500 has more than one lan interface, the lan interfaces are named lan1, lan2 and lan3 not just lan.

The screenshots in this document is from firmware version 2.04.00. If you are using a later version of the firmware, the screenshots may not be identical to what you see on your browser.

To prevent existing settings to interfere with the settings in these guides, reset the firewall to factory defaults before starting.

7b

Virtual private network using a PPTP (or L2TP) lan-to-lan tunnel

Create one lan-to-lan PPTP VPN tunnel between firewall A and B. Firewall B is the server and firewall A the client.

If a L2TP tunnel is going to be used, instead of PPTP, follow the steps in this guide but change tunnel protocol from PPTP to L2TP in step 2 and 6. The other settings are same in both cases.

- a IP: 192.168.1.1
- b IP: 192.168.110.1
Mask: 255.255.255.0
Gateway: 192.168.110.2
- c IP: 192.168.110.2
Mask: 255.255.255.0
Gateway: 192.168.110.1
- d IP: 192.168.2.1

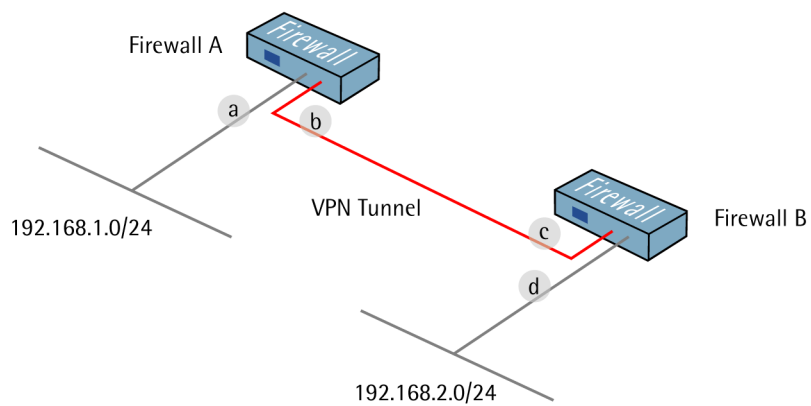

1. Firewall A - Addresses

Go to *Objects* -> *Address book* -> *InterfaceAddresses*.

Edit the following items:

Change `lan_ip` to `192.168.1.1`

Change `lanet` to `192.168.1.0/24`

Change `wan1_ip` to `192.168.110.1`

Change `wan1net` to `192.168.110.0/24`

Go to *Objects* -> *Address book*.

Add a new **Address Folder** called **RemoteHosts**.

In the new folder, add a new IP4 Host/Network:

Name: `fwA-remotenet`

IP Address: `192.168.1.0/24`

Click Ok



2. Firewall A - PPTP client interface

Go to *Interfaces* -> *L2TP/PPTP Clients*.

Add a new L2TP/PPTP Client.

In the **General** tab:

General:

Name:	<input type="text" value="fwB-pptp"/>
Tunnel Protocol:	<input type="text" value="PPTP"/>
Remote Endpoint:	<input type="text" value="fwB-remotegw"/>
Remote Network:	<input type="text" value="fwB-remotenet"/>

Name: **PPTPClient**

Tunnel Protocol: **PPTP**

Remote Endpoint: **fwB-remotegw**

Remote Network: **fwB-remotenet**

Authentication:

Username:	<input type="text" value="userA"/>
Password:	<input type="password" value="*****"/>
Confirm Password:	<input type="password" value="*****"/>

Username: userA

In the Security tab:

Authentication:

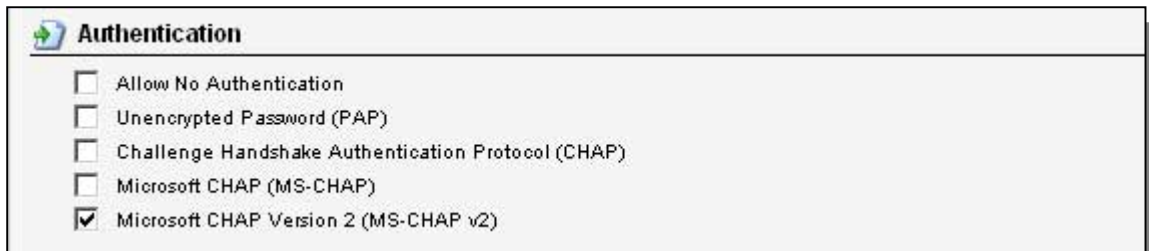

Authentication

- Allow No Authentication
- Unencrypted Password (PAP)
- Challenge Handshake Authentication Protocol (CHAP)
- Microsoft CHAP (MS-CHAP)
- Microsoft CHAP Version 2 (MS-CHAP v2)

The only options that should be checked is **Microsoft CHAP Version 2 (MS-CHAP v2)**

Microsoft Point-to-Point Encryption (MPPE):

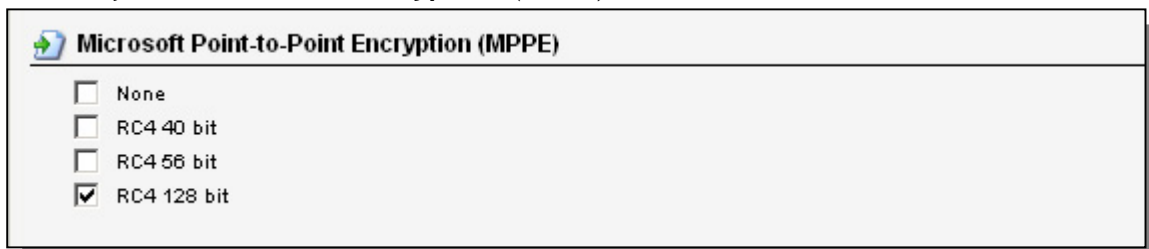

Microsoft Point-to-Point Encryption (MPPE)

- None
- RC4 40 bit
- RC4 56 bit
- RC4 128 bit

Only **RC4 128 bit** should be checked. (Using MS-CHAP v2 and 128 bit is the most secure option.)

3. Firewall A - Rules

Go to *Rules -> IP Rules*.

Create a new IP Rules Folder called `lan_to_fwB-pptp`

In the new folder, create a new IP Rule.

In the **General** tab:

General:



Name:

Action:

Service:

Schedule:

Name: `allow_all`

Action: `Allow`

Service: `all_services`

Address Filter:

	Source	Destination
Interface:	lan	fwB-pptp
Network:	lannet	fwB-remotenet

Source Interface: **lan**
Source Network: **lannet**
Destination Interface: **fwB-pptp**
Destination Network: **fwB-remotenet**

Click Ok.

Create a second rule in the same folder.

In the **General** tab:

General:

Name: **allow_all**
Action: **Allow**
Service: **all_services**

Address Filter:

	Source	Destination
Interface:	fwB-pptp	lan
Network:	fwB-remotenet	lannet

Source Interface: **fwB-pptp**
Source Network: **fwB-remotenet**
Destination Interface: **lan**
Destination Network: **lannet**

Click Ok.

Save and activate the configuration on firewall A.

4. Firewall B - Addresses

Go to *Objects* -> *Address book* -> *InterfaceAddresses*.

Edit the following items:

Change **lan_ip** to **192.168.2.1**

Change **lannet** to **192.168.2.0/24**

Change **wan1_ip** to **192.168.110.2**

Change **wan1net** to **192.168.110.0/24**

Go to *Objects* -> *Address book*.

Add a new Address Folder called **RemoteHosts**.

In the new folder, add a new IP4 Host/Network:

Name: **fwA-remotenet**

IP Address: **192.168.1.0/24**

Add a new Address Folder called **IPpools**.

In the new folder, add a new IP4 Host/Network:

Name: **fwA-ippool**

IP Address: **192.168.2.100-192.168.2.199**

Click Ok

5. Firewall B - User database

Go to *User Authentication -> Local User Databases*.

Add a new Local User Database called **PPPUsers**.

In the new database, add a new User:

General:



The screenshot shows a configuration form with the following fields:

- Username:
- Password:
- Confirm Password:
- Groups:

Username: **userA**

Per-user PPTP/L2TP IP Configuration:

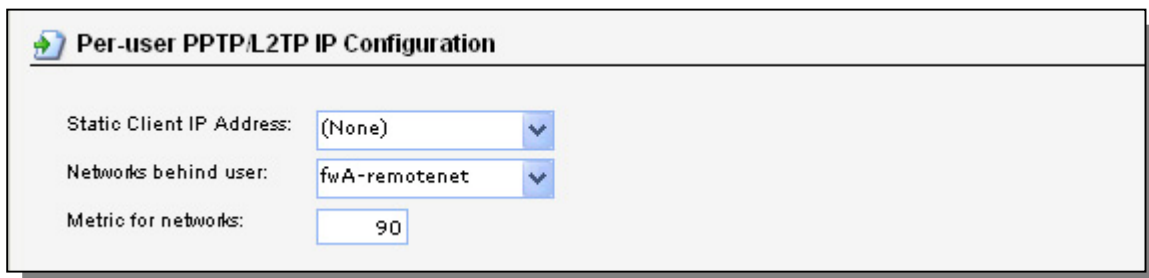

The screenshot shows a configuration form titled "Per-user PPTP/L2TP IP Configuration" with the following fields:

- Static Client IP Address:
- Networks behind user:
- Metric for networks:

Static Client IP Address: **(None)**

Networks behind user: **fwA-remotenet**

Metric for networks: **90**

6. Firewall B - PPTP Server interface

Go to *Interfaces* -> *L2TP/PPTP Server*.

Add a new L2TP/PPTP Server.

In the **General** tab:

General:

Name:	fwA-pptp
Inner IP Address:	lan_ip
Tunnel Protocol:	PPTP
Outer Interface Filter:	wan1
Server IP:	wan1_ip

Name: **fwA-pptp**

Inner IP Address: **lan_ip**

Tunnel Protocol: **PPTP**

Outer Interface Filter: **wan1**

Server IP: **wan1_ip**

In the **PPP Parameters** tab:

General:

Check the **Use User Authentication Rules** option

Microsoft Point-to-Point Encryption (MPPE):

 Microsoft Point-to-Point Encryption (MPPE)
<input type="checkbox"/> None
<input type="checkbox"/> RC4 40 bit
<input type="checkbox"/> RC4 56 bit
<input checked="" type="checkbox"/> RC4 128 bit

Only **RC4 128 bit** should be checked.

IP Pool:

 IP Pool		
IP Pool:	fwA-ippool	
DNS:	Primary: (None)	Secondary: (None)
NBNS:	Primary: (None)	Secondary: (None)

IP Pool: **fwA-ippool**

Click Ok.

7. Firewall B - User authentication rules

Go to *User Authentication* -> *User Authentication Rules*.

Add a new *User Authentication Rule*.

In the *General* tab:

General:

Name:	<input type="text" value="pptp-ua"/>	
Agent:	<input type="text" value="ppp"/>	▼
Authentication Source:	<input type="text" value="Local"/>	▼
Interface:	<input type="text" value="fwA-pptp"/>	▼
Originator IP:	<input type="text" value="fwA-remotegw"/>	▼
Terminator IP:	<input type="text" value="wan1_ip"/>	▼

 For XAuth and PPP, this is the tunnel originator IP.

Name: **pptp-ua**

Agent: **PPP**

Authentication Source: **Local**

Interface: **fwA-pptp**

Originator IP: **fwA-remotegw**

Terminator IP: **wan1_ip**

In the *Authentication Options* tab:

General:

Radius Method:	<input type="text" value="PAP"/>	▼
Local User DB:	<input type="text" value="PPPUsers"/>	▼

Local User DB: **PPPUsers**

Click Ok.

8. Firewall B - Rules

Go to *Rules* -> *IP Rules*.

Create a new *IP Rules Folder* called **lan_to_fwA-pptp**

In the new folder, create a new *IP Rule*.

In the General tab:

General:

Name:	<input type="text" value="allow_all"/>
Action:	<input type="text" value="Allow"/> ▼
Service:	<input type="text" value="all_services"/> ▼
Schedule:	<input type="text" value="(None)"/> ▼

Name: allow_all

Action: Allow

Service: all_services

Address Filter:

Source Interface: lan

Source Network: lannet

Destination Interface: fwA-pptp

Destination Network: fwA-remotenet

Click Ok.

Create a second rule in the same folder.

In the General tab:

General:

Name: allow_all

Action: Allow

Service: all_services

Address Filter:

Source Interface: fwA-pptp

Source Network: fwA-remotenet

Destination Interface: lan

Destination Network: lannet

Click Ok.

Save and activate the configuration on firewall A.