



D-Link *AirPremier*
DWL-1800
Wireless Outdoor Bridge
User's Manual

First Edition (July 2002)

Printed in Taiwan



RECYCLABLE

TABLE OF CONTENTS

1. Introduction.....	1
1.1 Using this Guide.....	1
1.2 System Description.....	1
1.2.1 General.....	1
1.2.2 D-Link AirPremier DWL-1800 DWL-1800 Functional Description	2
1.2.2.1 DWL-1800 (BU) Wireless Base Unit.....	2
1.2.2.2 DWL-1800(RB) Wireless Bridge	3
1.2.3 D-Link AirPremier DWL-1800 Compatibility and Standards	3
2. Installation.....	4
2.1 Packing List	4
2.2 Installation Overview.....	4
2.3 Outdoor Installation Considerations	5
2.3.1 Collocating DWL-1800 Outdoor Units	6
2.3.2 Site Selection Factors.....	6
2.3.3 Rooftop Installation	7
2.3.4 Antennas for Outdoor Applications	7
2.3.5 Antenna Polarization	8
2.3.6 Cell Size/Link Distance.....	8
2.3.7 Using Outdoor Range Tables.....	8
2.3.8 Precautions	8
2.3.9 Compliance with Radio Regulations	9
2.4 Installing the Outdoor Unit	9
2.4.1 Connecting the Ground and Antenna Cables.....	11
2.4.2 Connecting the Indoor-to-Outdoor Cable	11
2.5 Installing the Indoor Unit	12
2.5.1 Configuring Parameters.....	14
2.5.2 Antenna Alignment	14
2.6 Verifying Correct Operation.....	16
2.6.1 Verifying Correct Operation of the Indoor Unit.....	16
2.6.2 Verifying Correct Operation of the Outdoor Unit	17
3. The DWL-1800 Configuration Utility.....	18
3.1 Installing and Running the Configuration Utility.....	19

3.2	Configuration Utility Modes.....	19
3.2.1	Unit Configuration Mode	20
3.2.1.1	The Control Window	21
3.2.1.2	Application Control Buttons	23
3.2.1.3	Configuration Utility Tabs	24
3.2.2	Firmware Upgrade Mode.....	37
3.2.2.1	Advanced TFTP Settings	40
3.2.3	Multiple Unit Configuration Mode.....	41
3.3	Resetting the SNMP Community Strings	42
3.4	Reloading Factory Default Settings	42
4.	System Troubleshooting.....	43
4.1	Troubleshooting Guide	43
5.	Technical Specifications	45
5.1	Supported Standards	45
5.2	Configuration and Management.....	45
5.3	Radio	45
5.4	Range	46
5.5	Security	46
5.6	Outdoor Unit-to-Indoor Unit Communication	46
5.7	Interfaces.....	46
5.8	Electrical.....	47
5.9	Mechanical Dimensions	48
5.10	Environmental.....	48
5.11	Standards Compliance, General.....	48
APPENDIX A.	DWL-1800 FAQ	49
	General.....	49
	Collocation	51
	Performance	52
	Firmware.....	53
	Configuration.....	54
	Management.....	55
APPENDIX B.	PREPARING THE INDOOR TO OUTDOOR CABLE... 56	
APPENDIX C.	RADIO SIGNAL PROPAGATION..... 57	

TABLE OF FIGURES

Figure 1: DWL-1800 Point-to-Multipoint Application	2
Figure 2: General Installation Scheme - Pole Mounting	5
Figure 3: Holes/Grooves/Screw Holes.....	10
Figure 4: 3” Pole Mounting Installation Using the Supplied Brackets	11
Figure 5: The Waterproof Seal.....	11
Figure 6: Wall Mounting the Indoor Unit	13
Figure 7: Indoor Unit Bottom Panel.....	13
Figure 8: Indoor Unit Top Panel.....	14
Figure 9: DWL-1800 Configuration Utility Main Window (Station Control Tab)	21
Figure 10: The Set IP Dialog Box.....	22
Figure 11: Station Status Tab.....	24
Figure 12: IP Parameters Tab.....	25
Figure 13: SNMP Parameters Tab.....	26
Figure 14: Counters Tab (BU Units).....	27
Figure 15: Counters Tab (RB Units).....	27
Figure 16: WLAN Parameters Tab (BU Units).....	29
Figure 17: WLAN Parameters Tab (RB Units).....	30
Figure 18: The Station Control Tab.....	33
Figure 19: Security Tab	34
Figure 20: Advanced Tab.....	35
Figure 21: Trap Monitor Tab.....	37
Figure 22: Firmware Upgrade Mode dialog box	38
Figure 23: Firmware Upgrade Process.....	39
Figure 24: Advanced TFTP Setup dialog box	40
Figure 25: Multiple Configuration Mode dialog box	41
Figure 26: Ethernet Connector Pin Assignments	56
Figure 27: A Typical Radio System.....	577
Figure 28: Attenuation of an RF signal.....	588
Figure 29: Radiation Pattern of Directional Antenna.....	60
Figure 30: Multipath Reception.....	62
Figure 31: Fresnel Zone	63
Figure 32: Fresnel Zone Clear of Obstacles.....	64

TABLE OF TABLES

Table 1: Indoor Unit LEDs 16

Table 2: Outdoor Unit LEDs..... 17

Table 3: Regulatory Domains Specifications 32

Table 4: Frequency List 321

1. INTRODUCTION

1.1 Using this Guide

This User's Manual provides instructions for planning and setting up a Wireless link based on the D-Link *Air Premier* DWL-1800 Series wireless base unit and remote bridge.

Chapter 1: Introduction - Explains how to use this manual and presents the D-Link Air Premier DWL-1800 series.

Chapter 2: Installation - Describes how to install the units.

Chapter 3: The DWL-1800 Series Configuration Utility - Describes how to use the DWL-1800 Configuration Utility to setup, configure, and manage D-Link Air Premier DWL-1800 series units.

Chapter 4: System Troubleshooting - Solves some of the more common problems which may occur when installing and using the D-Link Air Premier DWL-1800 products.

Chapter 5: Software Download Procedure - Explains how to perform software upgrades using a TFTP application.

Chapter 6: Technical Specifications - Lists the technical specifications for the D-Link Air Premier DWL-1800 series units.

Appendix A: DWL-1800 FAQ- Answers questions frequently asked by customers.

Appendix B: Preparing the Indoor to Outdoor Cable: Explains how to prepare and install the cable connecting the indoor to the outdoor unit.

Appendix C: Radio Signal Propagation - Explains many of the terms and concepts related to antennas and RF (Radio Frequency) systems.

1.2 System Description

1.2.1 General

The **D-Link AirPremier DWL-1800 Wireless Base Unit** (DWL-1800B) and **Wireless Remote Bridge** (DWL-1800R) are designed to provide long-range point-to-multipoint links for outdoor applications. The products use direct sequence spread spectrum radio technology operating at the frequency range of 2.4 – 2.4835 GHz, a part of the FCC's unlicensed Industrial, Scientific, Medical (ISM) band.

Data is transmitted at rates of up to 11 Mbps, providing network users with full 10BaseT Ethernet speeds.

1.2.2 D-Link AirPremier DWL-1800 Functional Description

The D-Link Air Premier DWL-1800Series, DWL-1800B (BU) and DWL-1800R(RB), can be used as high-speed connections between two or more remote networks.

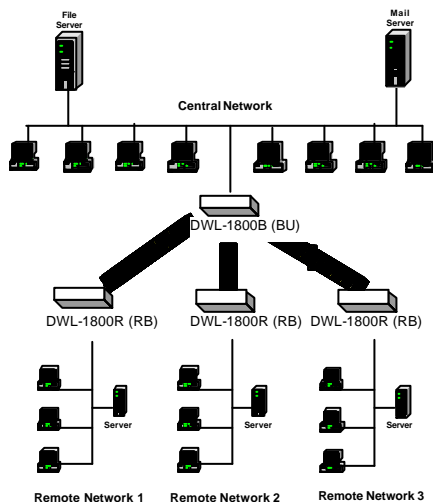

Figure 1: DWL-1800 Point-to-Multipoint Application

1.2.2.1 DWL-1800B (BU) Wireless Base Unit

The DWL-1800B is an IEEE 802.11b compliant base station that connects one or more remote sites to a central server or Internet connection. In a point-to-multi-point configuration the DWL-1800B is the central unit while in point-to-point configurations it should be installed at one end of the link.

The DWL-1800B is the basic unit, equipped with an antenna integrated into the front cover of the outdoor unit.

1.2.2.2 DWL-1800R (RB) Wireless Bridge

The DWL-1800 Wireless Bridge connects a remote Ethernet network to a central network server or Internet site via a DWL-1800 Multipoint Base .

The maximum number of MAC addresses that the unit can handle at any specific time is 1024 and the Aging algorithm is applied at all times.

When a station on the Ethernet LAN sends a message that is not destined for a local station, the DWL-1800R forwards the message to the DWL-1800B. When the DWL-1800B receives a message destined for a station on the DWL-1800R's LAN, the DWL-1800B wirelessly forwards it to the DWL-1800R. In this manner, the DWL-1800R and the DWL-1800B work together like a standard network bridge.

The first time each station on the DWL-1800R's LAN sends a message, the station's address is registered by both the DWL-1800R and the DWL-1800B. It is possible for the DWL-1800R and DWL-1800B to store all the addresses necessary to support an entire LAN connected to a DWL-1800R.

The DWL-1800R is the basic unit, equipped with an antenna integrated into the front cover of the outdoor unit.

1.2.3 D-Link *AirPremier* DWL-1800 Compatibility and Standards

D-Link Air Premier DWL-1800 products are compatible with the following standards and are interoperable with other IEEE 802.11b compatible, 2.4 GHz direct sequence products.

- ?? IEEE 802.11b Wireless LAN.
- ?? IEEE 802.3 10BaseT Ethernet.
- ?? DHCP for automatic IP address assignment.
- ?? SNMP for system management.

2. INSTALLATION

2.1 Packing List

Verify that all of the following items are included with the unit:

- ?? Indoor unit.
- ?? Outdoor unit (includes integrated antenna).
- ?? Pole mounting kit for the Outdoor unit (includes two brackets and four sets of screws, nuts and washers).
- ?? 110/220 VAC Power Cord.
- ?? 20 meter Indoor-to-Outdoor cable.
- ?? 3 shielded RJ-45 connectors.
- ?? Configuration Utility CD including manual.

2.2 Installation Overview

1. Select appropriate locations for the outdoor unit, the antenna and the Indoor unit.
2. Mount the outdoor unit.
3. Connect a ground cable from the outdoor unit to an appropriate grounding point.
4. Connect the Indoor-to-Outdoor cable to the outdoor unit and route it to the location selected for the indoor unit. Refer to Appendix B for instructions on preparing the Indoor-to-Outdoor cable.
5. Mount the indoor unit. Connect the Indoor-to-Outdoor cable to the indoor unit's Radio port.
6. Connect the indoor unit's Ethernet port to the user's network using an Ethernet cable.
7. Configure the unit's parameters.
8. Align the antenna and verify connectivity with any other units.

NOTE: *The indoor unit should be connected to the power source only **after** it has been connected to the outdoor unit.*

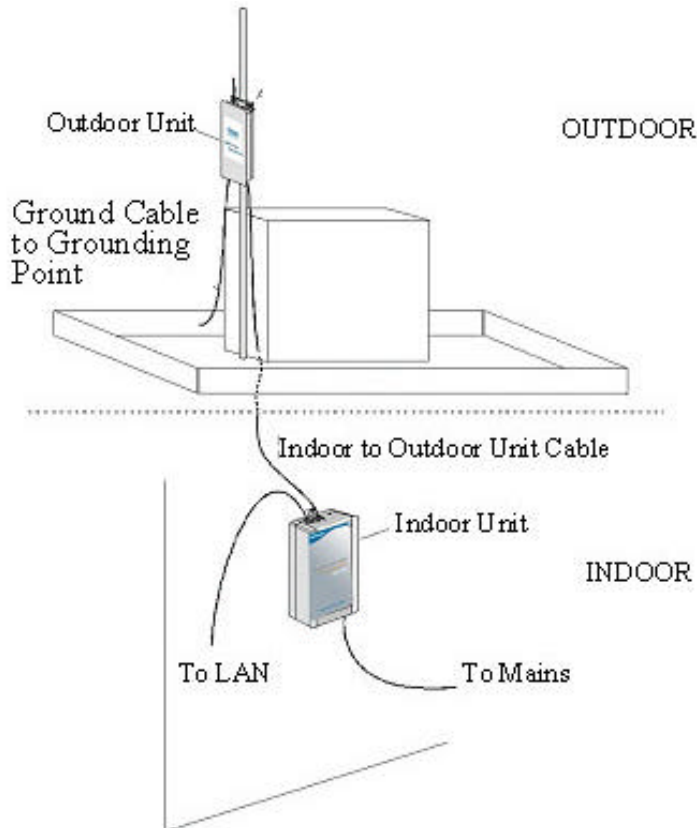

Figure 2: General Installation Scheme - Pole Mounting

NOTE: Use a straight Ethernet cable to connect the indoor unit to a hub, or use a crossed cable to connect it directly to a PC's Network Interface Card (NIC).

2.3 Outdoor Installation Considerations

This chapter describes various considerations to take into account when planning an outdoor installation including site selection, antenna alignment, antenna polarization and cell size.

2.3.1 Collocating DWL-1800 Outdoor Units

Up to three DWL-1800B units with integrated antennas (the exact number depends on the number of non-overlapping channels available in the relevant regulatory domain) can be collocated on the same building top or tower. Collocating more than three units may decrease performance depending upon the type of antenna and its direction. Each unit should be assigned to one of the non-overlapping channels: 1, 7, or 13 in ETSI or 1, 6 or 11 in FCC.

2.3.2 Site Selection Factors

When selecting a location for outdoor units and external antennas, remember to take into consideration the following guidelines:

- ?? Minimum distance between sites.
- ?? Maximum height above the ground.
- ?? Maximum line of sight clearance.

Path of Clearest Propagation

A propagation path is the path that signals traverse between the antennas of any two units. The “line” between two antenna sites is an imaginary straight line, which may be drawn between the two antennas. Any obstacles in the path of the “line” degrade the propagation path. The best propagation path is, therefore, a clear line of sight with good clearance between the “line” and any physical obstacle.

Physical Obstacles

Any buildings or other physical structures such as trees, mountains or other geographic features higher than the antenna and situated in the path between the two sites can constitute obstructions and cause signal attenuation. Install outdoor antennas high enough to avoid any obstacles, which may block the signal.

Path Loss

Path loss is determined mainly by several factors:

- ?? **Distance between sites** – Path loss is lower and system performance better when distances between sites are shorter.
- ?? **Clearance** – Path loss is minimized when there exists a clear line of sight. The number, location, size, and makeup of obstacles determine their contribution to path loss.
- ?? **Antenna height** – Path loss is lower when antennas are positioned higher. Antenna height is the distance from the imaginary line connecting the antennas at the two sites to ground level. Ground level in an open area is the actual ground. In dense urban areas, ground level is the average height of the buildings between the antenna sites.

2.3.3 Rooftop Installation

Rooftop installations offer several advantages:

- ?? Fewer obstacles in the path.
- ?? Improved performance due to greater height.

2.3.4 Antennas for Outdoor Applications

The D-Link *AirPremier* DWL-1800 series can be used in point-to-point or point-to-multipoint configurations.

Point-to-Point

The DWL-1800B/DWL-1800R is equipped with a directional antenna. The required antenna gain depends on the required range and performance.

Point-to-Multipoint

Setting up a point-to-multipoint link requires the use of a base unit equipped with an integrated antenna and at least two remote units also equipped with integrated antennas.

2.3.5 Antenna Polarization

Antenna polarization must be the same at both ends of the link. In most applications, the preferred orientation is vertical polarization, which is best for above ground propagation.

2.3.6 Cell Size/Link Distance

Cell size is determined by the maximum possible distance between the DWL-1800B and a DWL-1800R unit. For open outdoor areas with an unobstructed line of sight between the BU-DWL-1800B and the DWL-1800R units, the suggested maximum distance is up to 6 miles (10Km) where ETSI is the regulatory domain and 15 Miles (25 Km) where FCC is the regulatory domain.

2.3.7 Using Outdoor Range Tables

Specific range tables, guidelines and information about extended cables can be obtained from your local dealer or the D-Link central offices.

Outdoor installations must have a clear line-of-sight between antennas. Solid obstacles such as buildings or hills can prevent the establishment of a link while partial obstacles such as trees or traffic can reduce range. Extended coaxial cables can cause an increase in signal loss and a reduction in range.

2.3.8 Precautions

NOTE: *Outdoor units and antennas should be installed ONLY by experienced antenna installation professionals who are familiar with local building and safety codes and, wherever applicable, are licensed by the appropriate government regulatory authorities.*

The system complies with the ETS 300 385 standard and is protected against secondary lightning strikes when its outdoor unit is properly grounded according to the applicable country-specific industry standards for protection against lightning. The system complies with EN 61000-4-5, test level 3 (2kV).

Failure to do so may void the D-Link Air Premier DWL-1800 Product Warranty and may expose the end user to legal and financial liabilities. D-Link and its resellers or distributors are not liable for injury, damage or violation of government regulations associated with the installation of detached antennas.

2.3.9 Compliance with Radio Regulations

Regulations regarding maximum antenna gains vary from country to country. It is the responsibility of the end user to operate within the limits of these regulations as well as to ensure that the professional installer is aware of these regulations.

Violation of government regulations exposes the end user to legal and financial liabilities. D-Link, its resellers and distributors shall not be liable for expense or damage incurred as a result of installations that exceed local transmit power limitations.

2.4 Installing the Outdoor Unit

The outdoor unit can be secured to the pole using one of the following options:

- ?? Special brackets sets (supplied with each unit). There are two pairs of screw holes on the units, allowing the use of the brackets with various pole widths.
- ?? U-bolts - size A (inner installation holes, up to 2" pole).
- ?? U-bolt - size B (outside installation holes, up to 3" pole).
- ?? Metal bands (9/16" wide, minimum 12" long).

Figure 3 shows the locations of the holes, grooves and screw holes on the back of the unit.

Figure 4 illustrates the method of installing a unit on a pole using the supplied brackets.

NOTE: *Make sure to install the unit with the bottom panel (the panel with the signal strength bar and LEDs) facing downward.*

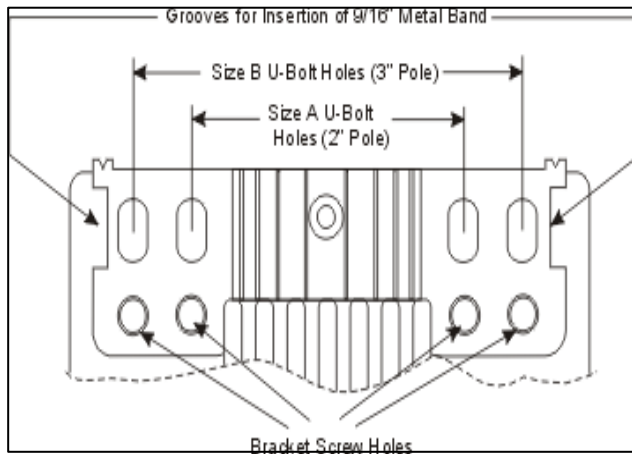

Figure 3: Holes/Grooves/Screw Holes

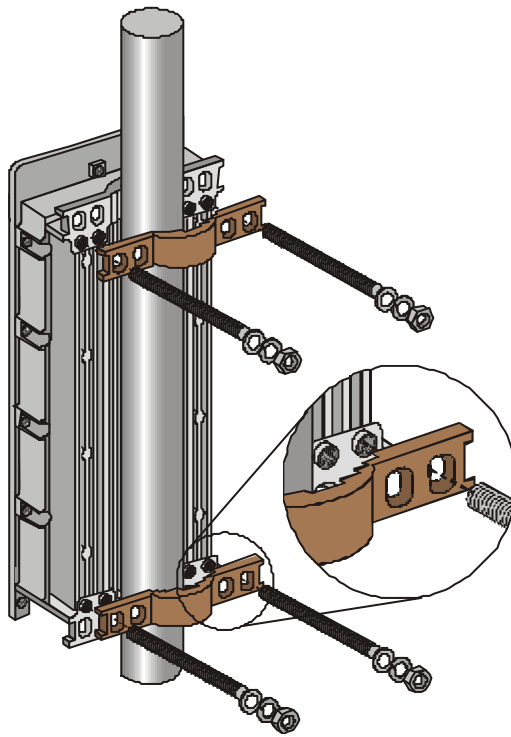

Figure 4: 3" Pole Mounting Installation Using the Supplied Brackets

NOTE: When inserting the open-ended screws, make sure to insert them with the grooves pointing outwards; these grooves are intended to allow fastening of the screws with a screwdriver.

2.4.1 Connecting the Ground and Antenna Cables

The Ground terminal (marked \oplus) is located on the bottom panel of the outdoor unit.

1. Connect one end of the grounding cable to the Ground terminal and connect the other end to a good ground connection.

2.4.2 Connecting the Indoor-to-Outdoor Cable

1. Remove the two screws holding the waterproof seal to the outdoor unit and remove the waterproof seal.
2. Unscrew the top nut from the waterproof seal.

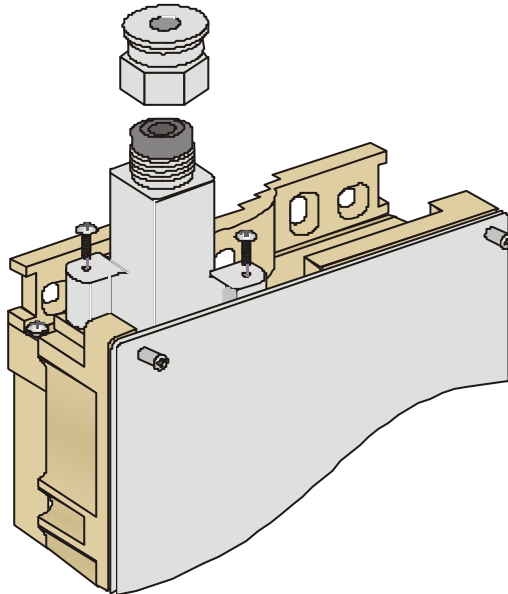

Figure 5: The Waterproof Seal

-
3. Route a straight, uncrimped Ethernet cable (8-wire, 24 AWG) through both the top nut and the waterproof seal.

NOTE: The 8-wire cable should be shielded.

4. Insert and crimp the RJ-45 connector. Refer to Appendix B for instructions on preparing the RJ-45 cable connector.
5. Connect the Ethernet cable to the Outdoor unit RJ-45 connector.
6. Replace the waterproof seal and then the top nut. Make sure that the external jack of the cable is well inside the waterproof seal to guarantee a good seal.
7. Route the cable to the location selected for the Indoor unit.

2.5 Installing the Indoor Unit

Route the Indoor-to-Outdoor cable into the building so that it conveniently reaches the indoor unit while avoiding interference sources. It is recommended that the cable be a little longer than necessary. The cable is supplied open ended so it can be conveniently threaded as shown into the building.

1. Remove the wall-mounting bracket clipped to the back of the indoor unit and mount it on a wall as shown in Figure 6. Mount the indoor unit on the mounting bracket.
2. Assemble an RJ-45 connector with a protective cover on the indoor side of the Indoor-to-Outdoor cable. Refer to Appendix B for instructions on preparing the RJ-45 cable connector.
3. Connect the Indoor-to-Outdoor cable to the Radio connector, located on the top panel of the indoor unit shown in Figure 8 on page 14. The Indoor-to-Outdoor cable should be connected to the unit before the unit is connected to the mains power.



Figure 6: Wall Mounting the Indoor Unit

NOTE: The color codes of the power cable are:

<i>brown</i>	<i>phase ~</i>
<i>blue</i>	<i>neutral 0</i>
<i>yellow/green</i>	<i>grounding ≡</i>

-
4. After connecting the outdoor unit to the indoor unit using the Indoor-to-Outdoor cable, connect the power cord to the unit's AC socket, located on the bottom panel shown in Figure 7. Connect the other end of the power cord to the AC mains after verifying that the unit is rated for the voltage in the country of use; the AC rating is indicated on the bottom panel of the Indoor unit.

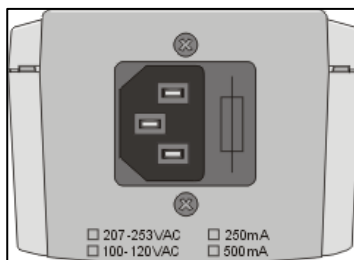

Figure 7: Indoor Unit Bottom Panel

-
5. Verify that the yellow POWER LED located on the top panel is lit, indicating that the unit is supplying power to the radio port.

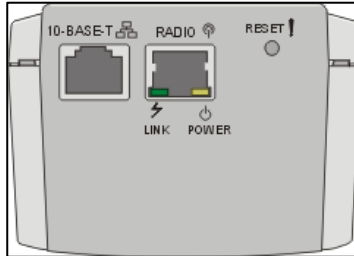

Figure 8: Indoor Unit Top Panel

6. Connect the 10BaseT connector to the network. The cable connection should be straight Ethernet if connecting the Indoor unit to a Hub and a crossed cable if connecting it directly to a PC Network Interface Card (NIC).

NOTE: *The length of the Ethernet cable connecting the indoor unit to the user's equipment, together with the length of the Indoor-to-Outdoor cable, should not exceed 90 meters.*

2.5.1 Configuring Parameters

Before aligning the antenna, certain key parameters must be configured to enable connectivity with linked units.

See Unit Configuration Mode on page 209 for more information.

2.5.2 Antenna Alignment

Usually, low gain antennas do not require alignment due to their very wide radiation pattern. High gain antennas, including the integral antenna of DWL-1800 units, have a narrow beamwidth necessitating an alignment procedure in order to optimize the link.

Check the antenna alignment by using the RSSI bar on the bottom panel of the DWL-1800R unit.

To align the antenna:

1. Confirm that the units at both ends of the link are receiving power.

-
2. Synchronize the units by aligning the antennas at the central and remote sites until maximum signal quality is obtained. Check the signal quality RSSI bar on the bottom panel of the DWL-1800R. The first LED lights red to indicate that the unit is working. The remaining nine LEDs light green to indicate the signal strength. The stronger the signal, the more LEDs are lit. Rotate the antenna to the left or right until you reach the point of maximum RSSI reading. Make sure that at all times the front of the antenna faces the general direction of the DWL-1800B.

2.6 Verifying Correct Operation

2.6.1 Verifying Correct Operation of the Indoor Unit

To verify proper operation, check the LED indicators located on the top panel of the indoor unit as shown in Figure 8 on page 14, and as described in Table 1.

Name	Description	Functionality
POWER	Power indication	<i>Green</i> - 48VDC is present on the Radio RJ45 port. <i>Off</i> - No power is supplied to the Radio RJ45 port.
LINK	Self Test and Ethernet Link indication	The LINK LED indicates end-to-end connection between the outdoor unit and the Ethernet connection to the indoor unit. <i>Off</i> – No Ethernet connectivity has been detected between the outdoor unit and the device connected to the indoor unit. <i>Orange</i> – Self-test passed and Ethernet connection is confirmed by the Outdoor unit (Ethernet integrity check passed).

Table 1: Indoor Unit LEDs

2.6.2 Verifying Correct Operation of the Outdoor Unit

To verify proper operation, check the LED indicators located on the bottom panel of the outdoor unit.



Name	Description	Functionality
WLAN 	Wireless Link Indicator	<i>Blinking Green</i> – Data received or transmitted on the wireless link. Blinking rate is slower when there is less wireless traffic.
DC Power 	Self Test and Power indication	<i>Green</i> – Power is available and self test passed. <i>Red</i> – Self test failed. Firmware did not load successfully.
ETH 	Ethernet activity/ connectivity indication	<i>OFF</i> –Ethernet connectivity is OK. No traffic activity detected on the port. <i>Blinking Green</i> –Ethernet connectivity is OK, with traffic on the port. <i>Red</i> – No Ethernet connectivity. When this state occurs, check the Ethernet cable and Indoor-to-Outdoor cable connections.
RSSI BAR		<i>DWL-1800R</i> : Received Signal Strength Indication <i>DWL-1800B</i> : Number of associated RB-DWL-1800R units

Table 2: Outdoor Unit LEDs

What to do if the Self Test fails

If the Self-Test failed (DC Power LED light remains red), try the following:

- ?? Reset unit (Disconnect/reconnect the power).
- ?? Check the Indoor-to-Outdoor cable.
- ?? Reset to factory defaults (see page 42).
- ?? Contact technical support.

3. THE D-LINK AIRPREMIER DWL-1800 CONFIGURATION UTILITY

The D-Link Air Premier DWL-1800 Configuration Utility is an SNMP-based utility that provides a consistent view of the wireless network. The system administrator can use the D-Link AirPremier DWL-1800 Configuration Utility to control a large number of DWL-1800 units from a single location. The Configuration Utility can be used to manage DWL-1800B(BU) and DWL-1800R (RB)units as well as other members of the D-Link wireless family including D-Link Air and Air Plus Series i.e. DWL-900AP, DWL-900AP+, DWL-520, DWL-520+, DWL-650, DWL-650+. The description in this manual, however, is limited to management and configuration of DWL-1800B and DWL-1800R units.

Using the Configuration Utility you can:

- ?? Assign radio channels for optimal cell operation.
- ?? Configure units with a specified IP address.
- ?? Set the SNMP Read/Write Community strings.
- ?? Verify the status of all units in the network.
- ?? Configuration of a wide range of operational parameters, including WLAN, IP and Security parameters.
- ?? View Tx and Rx counters.
- ?? Obtain general information such as the Firmware version and system name.

3.1 Installing and Running the Configuration Utility

The Configuration Utility is provided for installation on a 3.5" diskette.

1. Insert the provided diskette into the computer where you wish to install the Configuration Utility.
2. Run Brzmgr mgr.exe.
3. Follow all instructions until you are informed that the Utility was installed successfully.
4. Run the Configuration Utility from the Start menu by selecting it in the D-Link AirPremier DWL-1800 Configuration Utility folder under Programs.

3.2 Configuration Utility Modes

There are several D-Link AirPremier DWL-1800 Configuration Utility modes of operation; these options are selected via the Mode menu in the configuration utility main window (shown below). The selected mode(s) is indicated by a check mark in the menu.

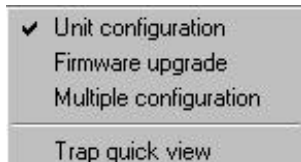

- ?? **Unit configuration** - This is the default mode and is used for setting parameters as detailed in this manual.
- ?? **Firmware upgrade** – Used for upgrading the embedded software in managed units; refer to Section 3.2.2 for instructions on using this feature.
- ?? **Multiple configuration** – Used for setting configuration parameters for more than one unit simultaneously; refer to Section 3.2.3 for instructions on using this feature.

-
- ?? **Trap quick view** - When set to this mode, the PC (if set as described in Section 3.2.1.3.3) switches automatically to the Trap Monitor tab when Unit Configuration mode is selected.

3.2.1 Unit Configuration Mode

The Control Window Section

In this section, you can:

- ?? Discover the units that are connected to the network.
- ?? View DWL-1800 units that have been discovered by their IP address.
- ?? Select the units you wish to manage.
- ?? Locate units behind a router that cannot be detected by the autodiscovery feature
- ?? Assign unit IP addresses based on unit MAC addresses.
- ?? Set the SNMP Community string.

If there are many units in the managed network, you can enlarge the list box by clicking on the horizontal line above the list; click again to toggle back the default display state. The list box also displays the Location of each unit, as set in the Station Status dialog box (see Section 3.2.1.3.1).

The Tabs Section

This section consists of several tabs, each containing parameters required for the management of the selected unit; the number of tabs displayed varies between the type of managed unit. The different tabs are described in the following sections. When you switch between the tabs, the unit selection section with the selected unit address remains displayed.

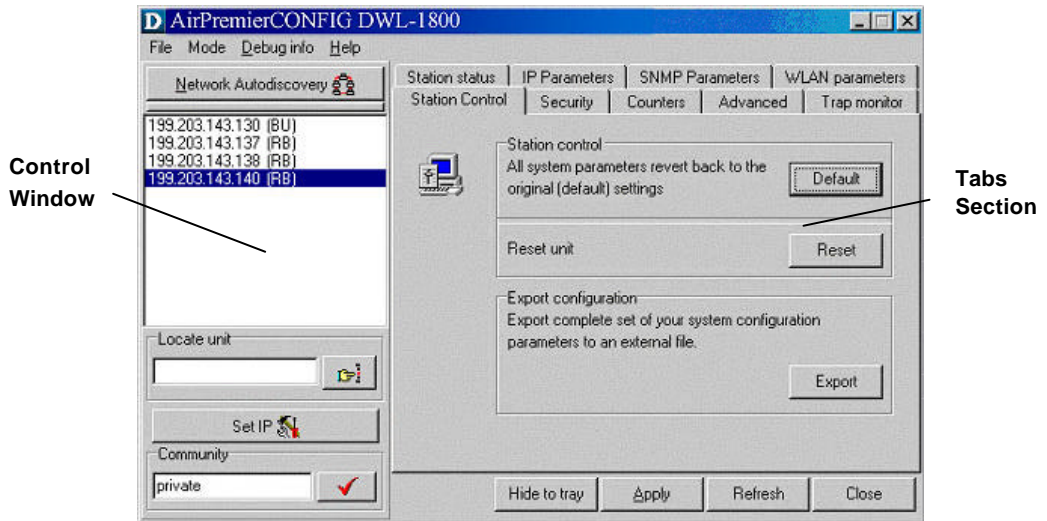



Figure 9: D-Link AirPremier DWL-1800 Configuration Utility Main Window (Station Control Tab)

3.2.1.1 The Control Window

3.2.1.1.1 Selecting Units

You can select a unit to manage in one of the following ways:

- ?? Click the Network Autodiscovery button. All the IP addresses of units in the same domain but not hidden behind a router (under the selected community) are displayed in the list box underneath the button. Click on an address to select the corresponding unit for viewing and configuration.
- ?? Type the unit's IP address in the Locate Unit field (for stations which are located behind a router) and click . This will add the unit information to the selection list.

3.2.1.1.2 Setting the SNMP Community String

Type the known Read/Write Community string in the Community field (the default string is public for read and private for read/write) and click the  button to confirm.

3.2.1.1.3 Assigning and Editing IP Addresses Manually (based on MAC addresses)

1. Click the **Set IP** button. The Set IP dialog box appears.

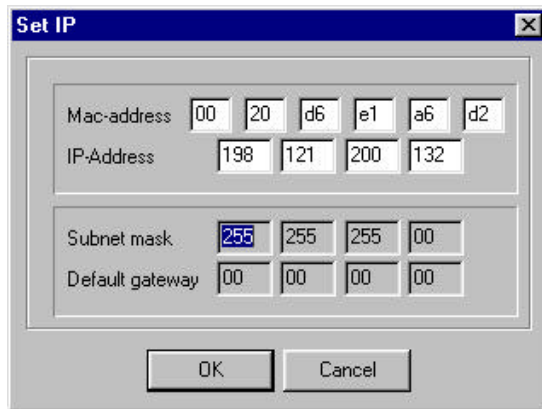

Figure 10: The Set IP Dialog Box



2. Type the parameters in the appropriate fields and click OK; the MAC address is shown on the bottom label of the Indoor and Outdoor units. A message box is displayed notifying you when the changes are to take affect. This feature can be used only if the D-Link AirPremier DWL-1800 Configuration Utility is on the same Ethernet segment as the unit and not behind the router.

NOTE: *In order to see the unit after assigning the IP address, the PC with the Configuration utility should be on the same IP subnet as the assigned IP address.*

Units receive auto IP address if there is no DHCP server and the unit is configured to work in the Smart mode as described in Section 3.2.1.3.2. The IP address will be chosen randomly in the 169.254.x.x range with a subnet mask of 255.255.0.0.

3.2.1.2 Application Control Buttons

The following buttons always appear at the bottom of the Configuration Utility window. Additional buttons, specific to certain tabs, are explained when relevant.

- ?? **Hide to Tray** – Minimizes the application into the  icon, placed in the Windows task bar (at the bottom of the Windows desktop). To restore the application, click the  icon.
- ?? **Apply** – Implements any changes you made.
- ?? **Refresh** – Refreshes the window with the most recent data from the unit.
- ?? **Cancel** – Closes the window without implementing any changes you made.

3.2.1.3 Configuration Utility Tabs

3.2.1.3.1 Station Status Tab

The Station Status tab displays general information regarding the unit's firmware and hardware versions as well as general unit address information.

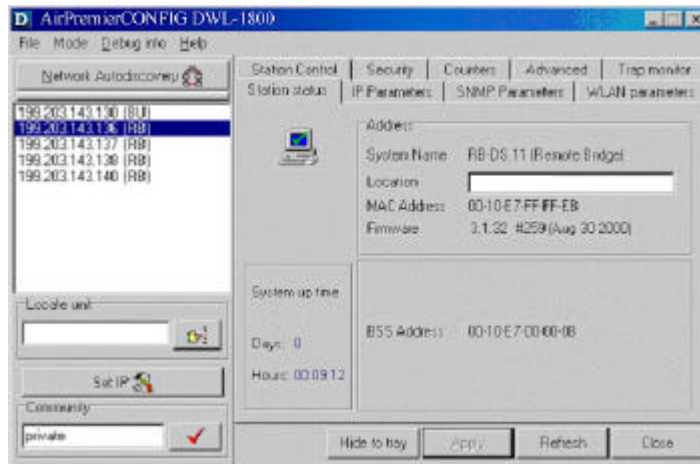

Figure 11: Station Status Tab

- ?? **System Name** - The name of the selected unit.
- ?? **Location** - A user-defined description of the location of the selected unit, up to 28 ASCII characters long (optional).
- ?? **MAC Address** - MAC address of the selected unit.
- ?? **Firmware** - The current firmware version.
- ?? **BSS Address** (DWL-1800R units only) - Defines the MAC address of the BSS, which is the DWL-1800B the unit is associated with.

3.2.1.3.2 IP Parameters Tab

The IP Parameters tab allows you to define or edit the IP parameters of units.

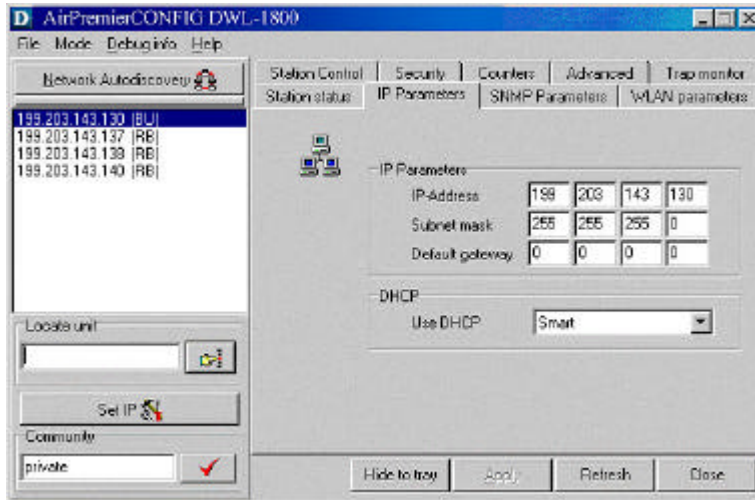

Figure 12: IP Parameters Tab

- ?? **IP Address** - The IP address of the selected unit.
- ?? **Subnet mask** - The Subnet mask of the selected unit.
- ?? **Default gateway** - The default gateway of the selected unit.
- ?? **DHCP** - Sets the way your system utilizes the Dynamic Host Configuration Protocol (DHCP, used for automatic IP assignment).

Always - The system searches for a DHCP server each time the unit is turned on.

Smart - The system searches for a DHCP server only if no IP address was assigned. If an IP address was assigned manually, the system will not search for a DHCP server.

Never - The system never searches for a DHCP server.

The default value is **Smart**.

NOTE: When the unit is configured to use a DHCP server and none exists, the unit will assign itself an automatic class B address in the range 169.254.X.X; this can be used with Auto Discovery when the MAC address is not available.

3.2.1.3.3 SNMP Parameters Tab

The SNMP parameters tab allows you to define or edit the SNMP community strings and the SNMP-related parameters.

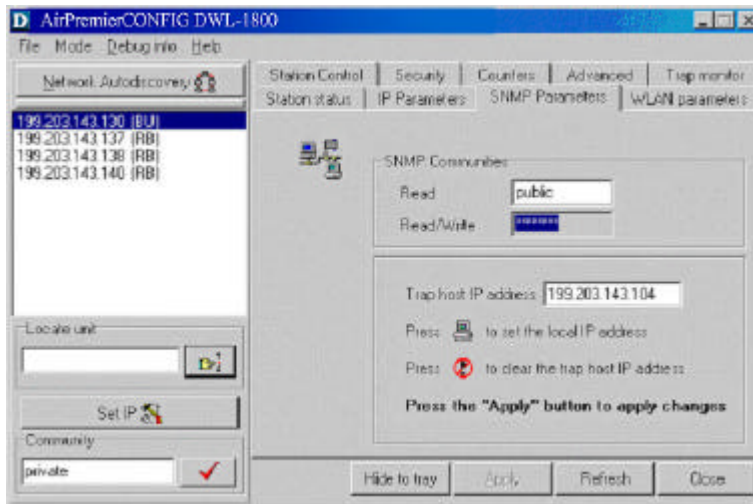



Figure 13: SNMP Parameters Tab

- ?? **Read** - The read-only community string of the unit. Default is public.
- ?? **Read/Write** - The read/write community string of the unit. Default is private. This value is displayed as asterisks for security purposes.
- ?? **Trap Host IP Address** - The IP address of the host to which SNMP traps are sent.

Click the  icon directly beneath this field to apply the defined Trap Host IP address.

Click the  icon directly beneath this field to disable the sending of traps (inserts a value of 255.255.255.255).

3.2.1.3.4 Counters Tab

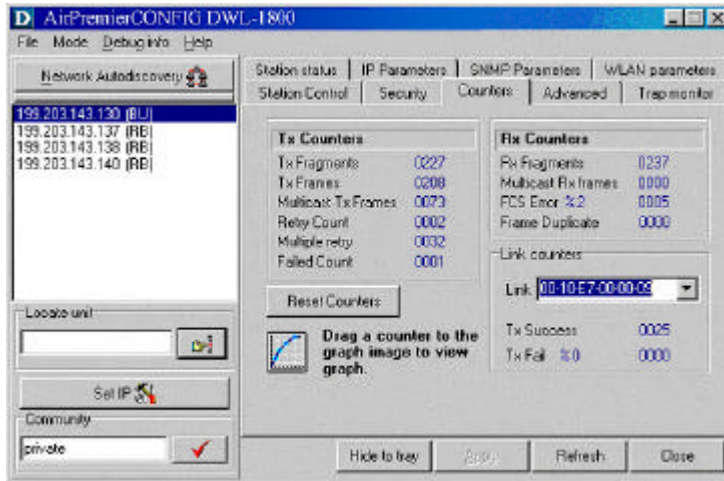

Figure 14: Counters Tab (BU/DWL-1800B Units)

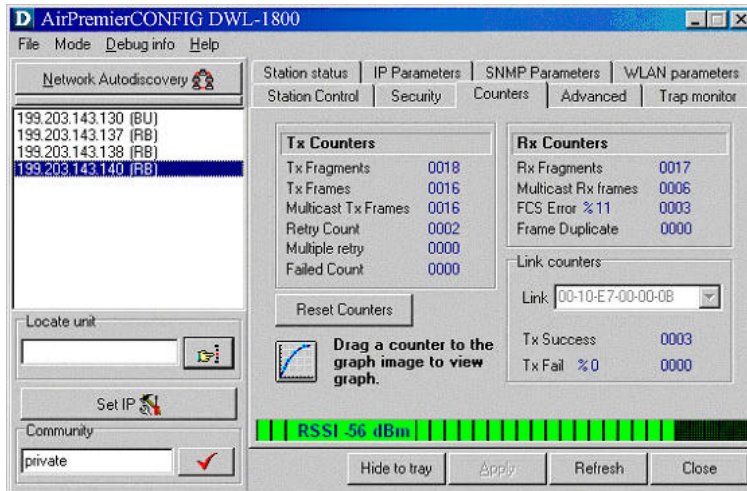



Figure 15: Counters Tab (RB/DWL-1800R Units)

Using the Counters windows, you can view a wide range of performance data at both sides of the link. For RB units, you can monitor the received signal strength through the RSSI (Received Signal Strength Indication) bar indicator at the bottom of the window. This RSSI bar can be used to optimize antenna alignment and improve link quality.

Additional performance counters displayed in this window include the following. To obtain a graph that displays the counter values, select a counter and drag it to the  icon.

?? Tx Counters

Tx Fragments - The number of transmitted frames. The count includes data, control, management frames and the number of retransmissions of data frames (for example, if the same data frame is retransmitted ten times then the count will increase ten times).

Tx Frames - The number of frames transmitted to the wireless media. The count includes the first transmission of data frames (without retransmissions), and the number of control and management frames.

Multicast Tx Frames- The number of transmitted multicast frames.

Retry Count - The number of retransmissions.

Multiple Retry - This counter is incremented when a packet is successfully transmitted after more than one retransmission.

Failed Count - This counter is incremented when a packet is not transmitted successfully due to the number of transmit attempts exceeding either the Short Retry Limit or Long Retry Limit.

?? Rx Counters

Rx Fragments - The number of frames received, including data, control, and duplicate data frames.

Multicast Rx - The number of received multicast frames.

FCS Error - The number of CRC errors, in addition to the percentage of CRC errors out of the total frames.

Frame Duplicate - The number of duplicate frames that were sent or received.

?? Link Counters

The Tx Success and Tx Fail counters displayed at the end of the counters list are link-specific; to activate these counters for a specific link, select the MAC address of the unit at the other end of the link and click Apply. When you click the Reset Counters button, these counters are actually reset (unlike the other counters which are only reset on screen).

Tx Success - The number of successfully sent Request To Send frames.

Tx Fail - The number of frames which the station failed to send.

Resetting Counters

You can reset the counters displayed in the Counters tab by clicking the **Reset Counters** button. All displayed values are reset to display zero.

Note that this action does not reset the counters stored in the actual unit, but just resets the values displayed in the screen (an exception to this are the Link Counters). Therefore, if you exit the Counters tab, after performing a reset and reopen it at a later time the counter values are displayed to reflect the values stored in the unit. To reset the counters in the unit, turn off the unit and then turn it back on.

3.2.1.3.5 WLAN Parameters Tab

The WLAN parameters tab allows you to define or edit parameters related to the Wireless LAN environment in which the selected unit is operating. The window displayed varies depending on the type of unit selected.

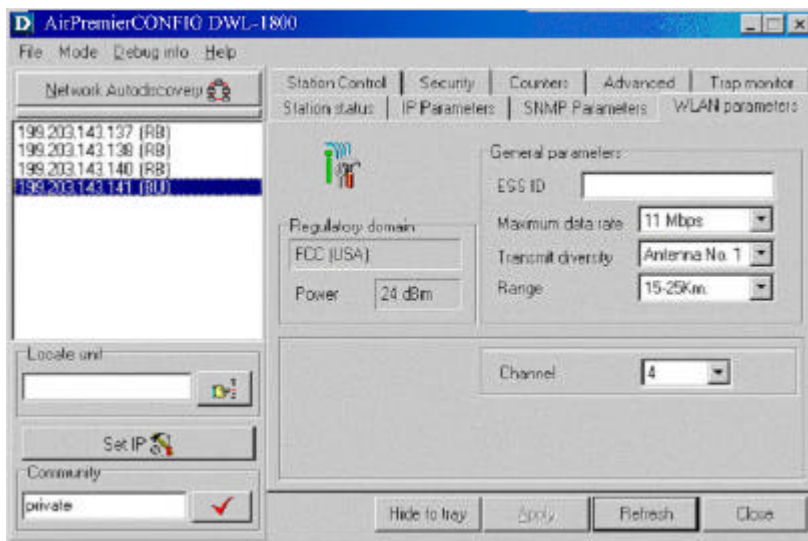

Figure 16: WLAN Parameters Tab (BU/DWL-1800B)

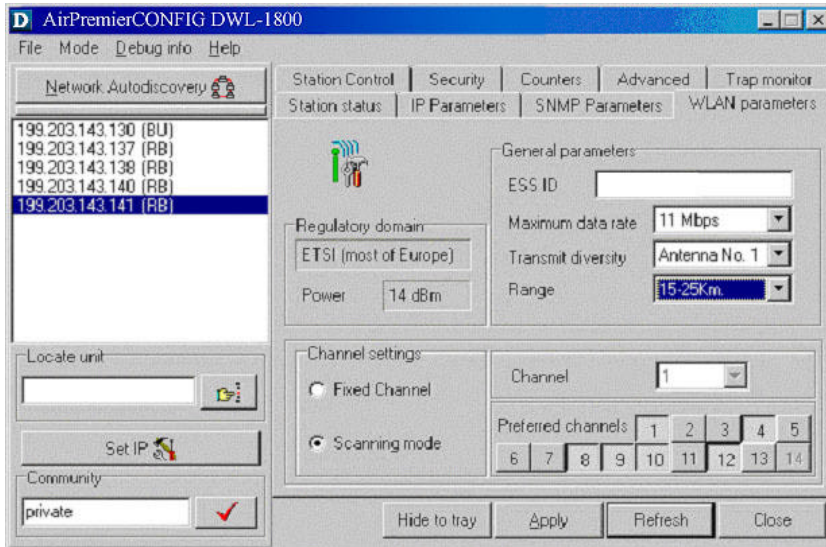

Figure 17: WLAN Parameters Tab (RB/DWL-1800R)

- ?? **Regulatory Domain** - Displays the regulatory authorities in the relevant country of use (e.g., Canada, ETSI, FCC, Japan).
- ?? **Power** - Displays the current output power level at the antenna port.
- ?? **ESSID** - An ASCII string of up to 32 characters used to identify a WLAN that prevents the unintentional merging of two co-located WLANs. It is essential that the ESSID is set to the same value in all Remote Bridges and Base Units that should communicate with each other. The ESSID field is case-sensitive.
- ?? **Maximum data rate** - By default, the unit adaptively selects the highest possible rate for transmission. Under certain conditions (for range/speed trade-off) you may decide not to use the higher rates. Possible values are 2, 5.5 or 11 Mbps. The default value is 11 Mbps.
- ?? **Transmit diversity** - The antenna diversity option, which must be set to Antenna No. 1.

NOTE: *In the present product release, antenna diversity is not supported; therefore, always select Antenna No. 1.*

?? **Range** - The operative range of your WLAN or Wireless Link in the drop down list. This parameter affects the acknowledge delay time which needs to be increased in long links. The default value is up to 5 km.

?? **Channel** - Channel selection varies, depending on the type of unit.

For DWL-1800B units, select the channel that the unit will use by selecting a value (range: 1-13, depending on your regulatory domain) from the Channel drop down menu. Refer to Table 4 on page 32 for the list of corresponding frequencies.

For DWL-1800R units, there are two channel setting options: if you select the *Fixed Channel* option by clicking the appropriate radio button, then the DWL-1800R will search for the DWL-1800B unit on the selected channel (from the Channel pull down field) and synchronize with it. The channel you select must match the channel selected in the DWL-1800B unit at the other end of the link.

If you select the *Scanning Mode* option (by selecting the appropriate radio button), you can specify preferred channels by clicking one or more of the buttons displayed at the bottom of the window. In this mode, the DWL-1800R will first search for the DWL-1800B unit on the channel you select in the Channel pull down field and synchronize with it if the link is established. If the DWL-1800R does not find the DWL-1800B, it will scan and search for one of the preferred channel frequencies you selected. If it does not find the DWL-1800B on any of the preferred channels, it will continue to scan until it finds the DWL-1800B on one of the channels permitted according to the regulatory domain.

Table 3 describes the channels used in each regulatory domain, the default channel, the maximum output power and the default output power.

Regulatory Domain	Lowest Channel	Highest Channel	Default Channel	Max. Output Power	Default Output Power
ETSI	1	13	7	14	4
FCC	1	11	6	24	24
TELEC	1	13	7	14	6

France	10	13	11	14	4
Canada	1	11	6	24	24

Table 3: Regulatory Domains Specifications

Channel	Frequency
1	2412 MHz
2	2417 MHz
3	2422 MHz
4	2427 MHz
5	2432 MHz
6	2437 MHz
7	2442 MHz
8	2447 MHz
9	2452 MHz
10	2457 MHz
11	2462 MHz
12	2467 MHz
13	2472 MHz

Table 4: Frequency List

NOTE: *The frequencies listed in the table are at the center of the channel. Each channel occupies 22MHz, therefore each channel occupies -11MHz to +11 MHz from the frequency specified.*

3.2.1.3.6 Station Control Tab

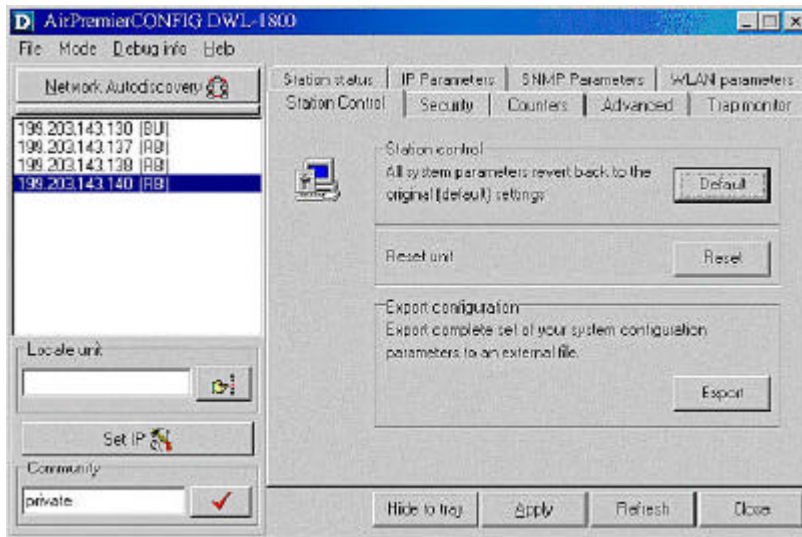

Figure 18: The Station Control Tab

- ?? **Station Control** - Click the Default button for all parameters to revert to the factory defaults.
- ?? **Reset Unit** - Click the Reset button to reset the unit and apply any changes made to the system parameters.
- ?? **Export Configuration** - Click the Export button to export the current basic configuration of this unit to a file. A popup window is displayed prompting you to specify the name of the file. The created file can be used to save the configuration information or to send it to tech support as a reference for troubleshooting.

3.2.1.3.7 Security Tab

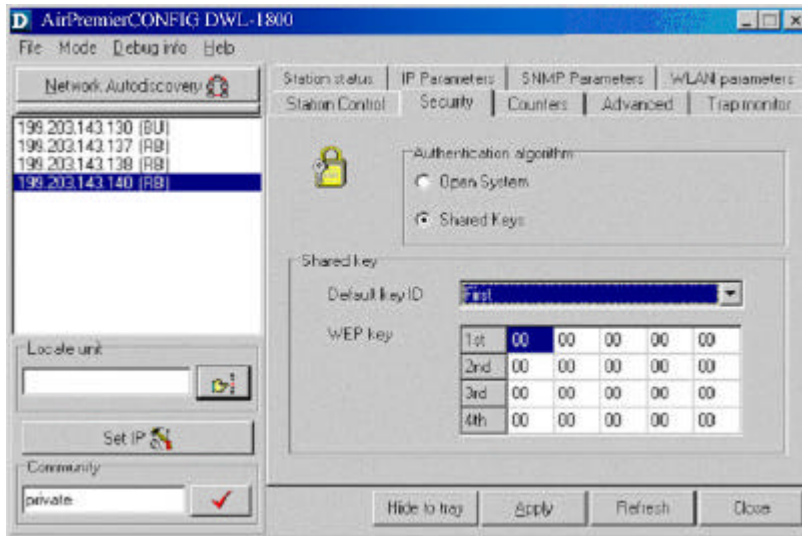

Figure 19: Security Tab

This tab displays information regarding the unit's security configuration. Wired Equivalent Privacy (WEP) is an authentication algorithm that protects authorized Wireless LAN users against eavesdropping and is implemented in D-Link AirPremier DWL-1800 units. WEP is defined in the IEEE 802.11b standard. This encryption is applicable for both authentication and data and the key length is 40 bits.

D-Link AirPremier DWL-1800 units can use one of the following authentication algorithms (as defined in the IEEE 802.11b standard).

- ?? **Open System** – Any station in the WLAN can associate with any other unit and receive and transmit data freely (null authentication).
- ?? **Shared Key** – Only stations using a shared key encryption are allowed to associate.

The default authentication algorithm is **Open System**.

If you select the Shared Key algorithm, set the following parameters:

- ?? **Default Key ID** – Sets the key for encryption.
- ?? **WEP Key** – Defines the encryption keys used. Define each key by clicking the appropriate WEP Key row and entering ten hexadecimal characters (five sets of two characters each) for each of the four keys. After clicking Apply, the WEP Key values are displayed as zeros for security reasons.

The default WEP key is the first key.

NOTE: All units in the same cell should use the same key.

3.2.1.3.8 Advanced Tab

The Advanced tab provides additional performance parameters.

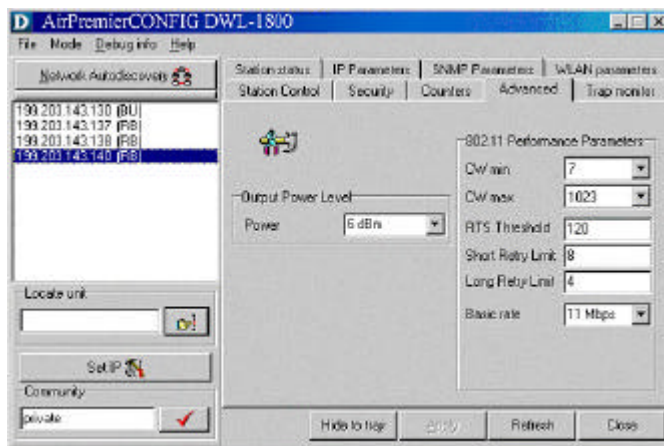

Figure 20: Advanced Tab

- ?? **CW Min/Max** - The size of the contention window. The contention window backoff algorithm is a method used to resolve contention between different stations trying to access the medium. The valid range is from 7 to 1023. Defaults are 31 for CW Min and 1023 for CW Max.
- ?? **RTS Threshold** - The minimum packet size required for an RTS (Request to Send) to be sent. For packets with a size below the RTS

Threshold value, an RTS is not sent and the data packet is transmitted directly to the WLAN.

- ?? **Short Retry Limit** - The maximum number of transmission attempts for a frame that is shorter than or equal to the RTS Threshold. The default value is 8.
- ?? **Long Retry Limit** - The maximum number of transmission attempts for a frame that is longer than the RTS Threshold. The default value is 4.
- ?? **Basic Rate** - The maximum rate of multicast, broadcast and control frames transmissions. Multicast and broadcast transmissions are not acknowledged; therefore there is a chance that such transmissions will not be properly received without the possibility of using the acknowledgement mechanism for retransmission. Therefore, it is recommended to use a lower rate for transmission of broadcast, multicast and control frames, to increase the probability that they will be received without errors. Enter the data rate at which broadcast, multicast and control frames are transmitted. The default value is 2 Mbps.

NOTE: The Basic Rate parameter should be changed only if you are sure that all units in the cell can handle the defined rate. Use this parameter with caution, as it may bring the link down.

- ?? **Power** – The transmit power level. The possible range is from -4dBm to +24dBm.

NOTE: The Power setting should not exceed the maximum output allowed in the applicable regulatory domain according to Table 3 on page 32.

3.2.1.3.9 Trap Monitor Tab

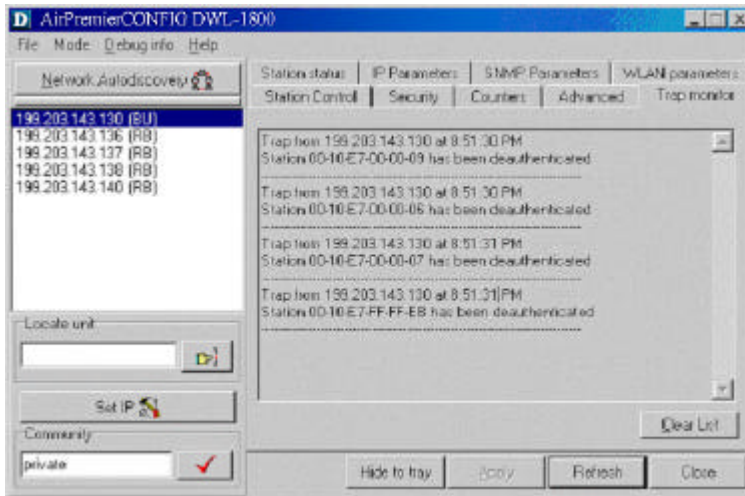

Figure 21: Trap Monitor Tab

When an event occurs, a trap is sent to the defined host address (the setting is made in the SNMP Parameters tab described in Section 3.2.1.3.3). This window displays the recorded traps.

Click the **Clear List** button to clear the display area.

3.2.2 Firmware Upgrade Mode

This mode allows the embedded software in managed units to be upgraded. When you select this mode from the Options menu, the following dialog box is displayed.

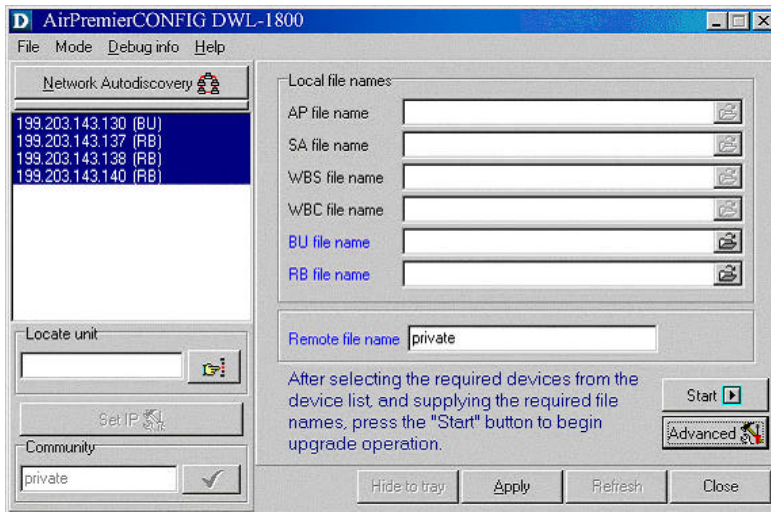

Figure 22: Firmware Upgrade Mode dialog box

NOTE: The Configuration utility does not resolve the topology of the cell. Therefore, firmware upgrades should be made from the central point where the BU/DWL-1800B are located.

The list box on the left-hand side of the dialog box displays the managed units; it is sorted sequentially by DWL-1800B followed by DWL-1800R units.

To upgrade firmware:

1. Select the units that you wish to upgrade from the list box. Use Shift-click and/or Ctrl-click to select multiple units, or select multiple units by dragging with the mouse.
2. Specify the firmware file you wish to use in the *Local file name* fields; there are separate fields for files of different device type. The field text is displayed in blue when corresponding unit types are selected in the list box.
3. In the Remote File Name field, enter the Read/Write community string of the unit(s).
4. Click **Advanced** if you wish to change the settings of the TFTP session used in the upgrade download (see 3.2.2.1).
5. Click **Start** to initiate the firmware upgrade; progress bars are displayed

indicating the progress of the operation. If both DWL-1800B and DWL-1800R devices are selected, the program will upgrade DWL-1800R units first.

At the end of the upgrade session, the following window is displayed indicating that the operation was successful.

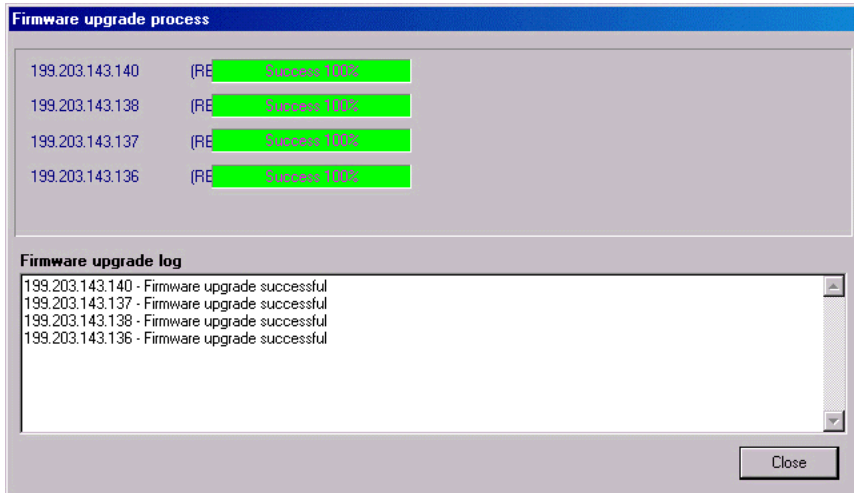

Figure 23: Firmware Upgrade Process

NOTE: Do not disconnect any cables or try to stop the process before downloading is completed.

All configured parameters are saved during the upgrade/download procedure.

3.2.2.1 Advanced TFTP Settings

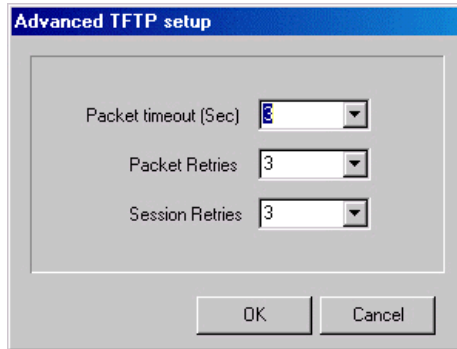

Figure 24: Advanced TFTP Setup dialog box

The Advanced TFTP Setup window enables you to tune the TFTP session parameters for a more efficient firmware upgrade, depending on your actual deployment.

- ?? **Packet timeout** - Defines the time (in seconds) it takes for a packet to timeout. The range is from 1 to 30 seconds with a default of 3 seconds.
- ?? **Packet Retries** - Defines the number of times that a packet will be sent after it timeouts in a TFTP session. The range is from 1 to 5 retries with a default of 3 retries.
- ?? **Session Retries** - Defines the number of times a TFTP session will be repeated before the firmware upgrade operation is designated a failure. The range is 1-5 retries with a default of 3 retries.

3.2.3 Multiple Unit Configuration Mode

This feature allows configuration parameters to be downloaded to multiple units simultaneously. When you select this option in the Options menu, all configuration windows become write-only. Irrelevant parameters are disabled.

NOTE: *The Configuration Utility does not resolve the topology of the cell. Therefore, multiple unit configuration operations should be done at the location where the DWL-1800B is are located.*

Select the units that you wish to upgrade from the list box on the left-hand side of any dialog box tabs. Use Shift-click and/or Ctrl-click to select multiple units.

Enter the configuration parameter values and click Apply. The following dialog box is displayed.

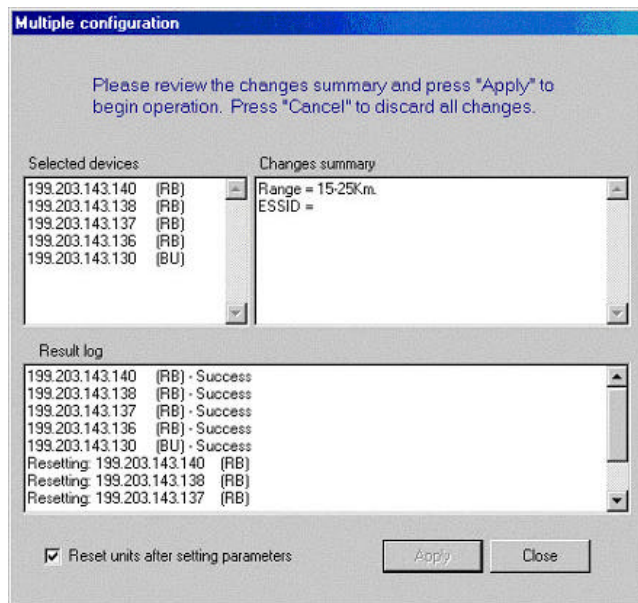

Figure 25: Multiple Configuration Mode dialog box

This dialog box lists the selected units and displays the configuration changes to be made during the multiple configuration session. Select the Reset units after setting parameters check box to reset all selected units.

A log of the multiple configuration session is displayed during and after the operation.

3.3 Resetting the SNMP Community Strings

The SNMP Read/Write Community strings are an SNMP security feature to restrict management access to authorized persons only. Refer to Section 3.2.1.1.2

To reset the SNMP community strings, insert a paper clip or another suitable tool into the Reset button on the top panel of the unit while the unit is operating. The community strings are reset to the default values, private (Write) and public (Read).

3.4 Reloading Factory Default Settings

To reset the unit to the factory defaults:

1. Disconnect the power cable from the indoor unit.
2. Insert a paper clip or another suitable tool into the Reset button on the top panel of the unit (see Figure 8 on page 14). Keep the Reset button pressed while inserting the power cable back into its socket.

4. SYSTEM TROUBLESHOOTING

The following troubleshooting guide provides answers to some of the more common problems that may occur when installing and using the D-Link Air Premier DWL-1800. If problems not mentioned in this guide should arise, checking the Ethernet and WLAN counters may help (see Section 3.2.1.3.4). If the problem persists, please feel free to contact your local distributor or the D-Link Technical Support Department.

4.1 Troubleshooting Guide

Problem and Indication	Possible Cause	Corrective Action
No power to unit. Power LED is off.	Power cord is not properly connected.	Verify power cord is properly connected to the DWL-1800 unit and to the power outlet.
Failure to establish wireless link. WIRELESS LINK LED is off and unit resets every few minutes.	1. Power supply to units may be faulty 2. The DWL-1800R units may not have the same ESSID as the DWL-1800B.	1. Verify power to units. 2. Verify that all units in the network have the same ESSID (ESSID must be identical in all units in the WLAN; the ESSID is case sensitive). Check that the units are on the same channel. 3. Verify wireless link ?? Set DWL-1800B and DWL-1800R units side by side. ?? Power on each unit and see if a wireless link is established (even "D" models without their external antennas should establish a link if placed side by side). ?? If the units fail to associate, reset units to factory default values (see Section 3.4). The units should now establish a wireless link.

Problem and Indication	Possible Cause	Corrective Action
Failure to establish wireless link (“D” models/external antennas)	<ol style="list-style-type: none"> 1. Power supply to units may be faulty. 2. Cables may be improperly connected 3. There may be some problem with antenna installation. 	<ol style="list-style-type: none"> 1. Verify power to units. 2. Verify that all cables are connected securely. 3. Refer to previous Section and verify wireless link between the units. 4. Verify that the antenna(s) are properly installed (see relevant section in this manual): <ul style="list-style-type: none"> ?? Check antenna alignment. ?? Verify that antenna polarization is the same at both ends. ?? Verify that the range matches specifications. ?? Verify line-of-sight/antenna alignment/antenna height.
Wireless link established, but there is no Ethernet activity (DWL-1800B and DWL-1800R units).	<ol style="list-style-type: none"> 1. Ethernet hub port or UTP cable is faulty. 2. Ethernet port in unit is faulty. 3. The DWL-1800R is associated to a DWL-1800B unit that is not connected correctly to the LAN. 	<ol style="list-style-type: none"> 1. Check that the LINK LED is lighted Green. If this is not the case, the port is inactive. Try another port on the hub or another UTP cable. 2. Verify that Ethernet port in unit is working. Ping unit to verify Ethernet connection. 3. Verify that you are using a cross-over UTP cable (pins 1 & 3, 2 & 6) if connected directly to a workstation, or a straight-through cable if connected to a hub. 4. Check the unit’s LINK LED indicator and check the Ethernet counters in the monitor to verify Ethernet activity (see Section 3.2.1.3.4). 5. Check that the DWL-1800B is correctly connected to the LAN.

5. TECHNICAL SPECIFICATIONS

5.1 Supported Standards

- ?? Compliant with ETS 300 328 and ETS 300 826 (CE marked).
- ?? IEEE 802.11b HR standard for Wireless LAN at 11 and 5.5 Mbps.
- ?? IEEE 802.11b standard for 1 and 2 Mbps.

5.2 Configuration and Management

Management and Setup	SNMP based Configuration Utility	
Site Survey Tool	Integrated into the configuration utility	
SNMP Agents	MIB II, Bridge MIB, DWL-1800 Private MIBs	
Software Upgrade	Simultaneous multiple units software upgrade using the configuration utility	
	TFTP download	
LED Indicators	Indoor Interface Unit	Outdoor Unit
	Power status	Power Status
	End-to-end Ethernet status	10-LED display bar: RSSI in the RB/ Load Gauge in BU
		Ethernet Status / Traffic
		Wireless Link Status / Traffic

5.3 Radio

Frequency Range	2.4 - 2.4835 GHz ISM band (ETSI, FCC) 2.4 - 2.4835 GHz (Japan)	
Radio Type	Direct Sequence Spread Spectrum (DSSS)	
Wireless LAN Standards	Compliant with IEEE 802.11b HR	
Selectable sub Channels	FCC	1-11
	ETSI	1-13
	Japan TELEC	1-13

	France	10-13	
Output Power (at the antenna port)	FCC	-4, -2, 4, 6, 12, 14, 20, 24	
	ETSI (dBm)	-4, -2, 4, 6, 12, 14	
	Japan TELEC	-4, -2, 4, 6, 12, 14	
Sensitivity (BER 10E-6)	Data Rate	Sensitivity	Modulation
	11 Mbit/s	-85 dBm	256 CCK
	5.5 Mbit/s	-88 dBm	16 CCK
	2 Mbit/s	-90 dBm	DQPSK
	1 Mbit/s	-93 dBm	DBPSK
Processing Gain	10.4 dB Nominal		
Integrated Antenna Type	Flat Panel 16 dBi, 20° Vertical /Horizontal		

5.4 Range

Europe/ ETSI (20 dBm EIRP)	Up to 10 km
US FCC	Up to 25 km (15 miles)

5.5 Security

Authentication and Data	40-bit RC4 WEP
------------------------------------	----------------

5.6 Outdoor Unit-to-Indoor Unit Communication

Cable Type	Cat 5 FTP 4x2x24 Double Jacket
Maximum Cable length between units	90 m (280 feet)

5.7 Interfaces

RF (antenna) connector in the outdoor unit (DWL-1800D models)	N-Type jack, lightning protected
--	----------------------------------

Baseband (indoor-to-outdoor units)	Outdoor units: Shielded RJ-45 with special water proof sealed cap
	Indoor units: Shielded RJ-45
Ethernet	Indoor units: 10BaseT, (RJ-45) with 2 embedded LEDs

5.8 Electrical

Power Consumption	110 /220 V 500 /250 mA
--------------------------	---------------------------

5.9 Mechanical Dimensions

Outdoor Unit	30 x 30 x 7.2 cm 12 x 4.7 x 2 in
Indoor Unit	15.4 x 8.4 x 5.6 cm 6.1 x 3.3 x 2.2 in

5.10 Environmental

Operating Temperature	Indoor unit: 0°C to 40°C Outdoor unit: -40°C to 55°C
Operating Humidity	5% to 95% non-condensing. Outdoor units are weather protected.

5.11 Standards Compliance, General

EMC	EN 300-385, FCC Part 15
Safety	EN 60950, UL 1950
Environmental	ETS 300 019
Radio	ETSI ETS 300 328, FCC Part 15

APPENDIX A. DWL-1800 FAQ

General

Can the DWL-1800R indoor unit be placed outdoors?

It is not recommended. The DWL-1800 indoor units are specified to operate between 0°C and 40°C and is not weather proof so it is best to mount the DWL-1800R indoors or in a protective cabinet.

Do DWL-1800 units support 802.1Q VLAN?

Yes, but the support is limited to transparent operation. This means that the DWL-1800 does not take any action on 802.1Q frames, but will transparently pass them within a VLAN network.

What is the maximum number of networked PCs the DWL-1800B/DWL-1800R can learn?

1024 network MAC addresses can be learned by the DWL-1800B/DWL-1800R from the LAN side.

Can the DWL-1800B/DWL-1800R be used for multi-point as well as point-to-point links?

Yes. The DWL-1800B can support multiple DWL-1800R units creating a point-to-multi-point network.

How many DWL-1800R units can one DWL-1800B support?

The maximum number of associations is 128.

What is the practical limit to the number of DWL-1800R units per DWL-1800B? And, what performance can I expect for a multi-point link?

This depends upon average throughput expectations. All clients would have the maximum throughput available for burst traffic, however the overall average would depend on the utilization of the network. For example, in a heavily utilized network needing about 350Kbps to 500kbps average net throughput per site, 9 to 12 DWL-1800R's would be the limit. For a moderately utilized network needing about 175Kbps to 258Kbps average, 18 to 24 DWL-1800R's should be used, and for a lightly used network needing 32Kbps to 48Kbps average net throughput per site could use up to 128 DWL-1800R's.

What is the range of the DWL-1800B/ DWL-1800R Bridges?

15 miles/24Km (FCC) or 10 KM (ETSI) can be achieved using the UNI-24 antenna kit for a point-to-point link. Consult the antenna and accessory guide range tables for distances using other antennas.

Does the DWL-1800B supports 802.1d spanning tree protocol?

No, the DWL-1800B/DWL-1800R does not support spanning tree.

What is the normal PER (Packet Error Rate) for the DWL-1800B/DWL-1800R?

The error rate will be about 4% -6% (transmitted fragments vs. retry count). This is typical when operating in a non-interference environment at maximum range for bi-directional traffic loads. If the traffic load is more uni-directional, then the PER will be less.

What is the best value for the CW min parameter on the DWL-1800?

Setting the CW min parameter to 31 for heavy bi-directional traffic loads will minimize the PER. Setting the CW min to 15 will improve performance for more uni-directional traffic loads. CW min 7 should only be used for short-range point-to-point links, and 63 should be used for large, long-range multi-point links.

Is the D-Link Air Premier DWL-1800 compatible with other D-Link wireless equipment from other vendors?

Yes. However, for the outdoor bridges, interoperability can vary from vendor to vendor and in some cases it may not operate if the manufacturer's implementation is not pure 802.11b. The DWL-1800B/DWL-1800R can operate at 1, 2Mbps 5.5Mbps and 11Mbps with D-Link Air and Air Plus wireless family products. D-Link Air Premier DWL-1800 units are fully WI-FI compliant.

Collocation

How many DWL-1800B or DWL-1800R units can be collocated on the same building or tower?

You can collocate up to 3 DWL-1800B or DWL-1800R units on the same structure. Each unit is assigned to one of the non-overlapping channels, 1, 6, or 11.

Can a Frequency Hopping network operate in the same area as the D-Link Air Premier DWL-1800?

Yes, but in a collocated network both products will suffer some a decrease in performance. The degree of performance loss depends on network utilization. For example, the higher the utilization of the Frequency Hopping network, the higher the level of impact on the Direct Sequence (DWL-1800) network, and vice versa. Typically, in light to moderately utilized networks, the performance loss is not significant.

Can I use D-Link Air Premier DWL-1800 Bridges to feed a Frequency Hopping distribution point?

Yes, bandwidth sharing between the Direct Sequence and Frequency Hopping products can be minimized if the network is designed using cross-polarized directional antennas with as much spatial separation as possible. Contact technical support for more information.

Performance

What is the throughput of the D-Link Air Premier DWL-1800?

The DWL-1800B/DWL-1800R bridge link typical performance is 4.2Mbps using TCP and 6.2Mbps using UDP. For long-range links, the performance drops by about 5%.

What if the D-Link Air Premier DWL-1800 link experiences interference?

If interference is affecting the DWL-1800 link, one of the other channels may be selected to operate away from the frequency of the interference. Also, physically re-locating the antennas may help.

What is the typical latency of a DWL-1800B/DWL-1800R?

A point-to-point link would realize about 3mS latency.

Firmware

Can the DWL-1800B/ DWL-1800R firmware be upgraded?

Yes, the firmware in the DWL-1800B/DWL-1800R is stored in flash and is upgraded using the built in Configuration Utility or the TFTP server.

Can the DWL-1800B/DWL-1800R flash be erased or the firmware changed by an unauthorized person?

No, the TFTP server in the DWL-1800B/DWL-1800R requires the SNMP write community name (password) to perform an upgrade.

Can the firmware flash be corrupted when upgrading to a new version?

Yes, if the TFTP file transfer is interrupted during a flash update the firmware may be corrupted. The D-Link Air Premier DWL-1800 has a backup flash, which contains the previous version for firmware. If the primary flash is corrupt, then the backup is automatically used to return the unit to an operating state.

When does the back up flash image get upgraded?

After completing a firmware upgrade, the backup flash containing the old firmware version is overwritten with the new version on the new power on cycle.

Can D-Link Air Premier DWL-1800 firmware be downgraded?

Yes, an earlier version of firmware can overwrite a newer version.

Can the previous version of firmware be kept?

The previous version of firmware cannot be kept on the DWL-1800 itself, but can be stored on your PC and loaded if needed.

Configuration

Can the regulatory domain (country) of a DWL-1800 unit be changed?

No. The regulatory domain is factory set.

How can the DWL-1800 be configured or managed if the SNMP Community name has been forgotten?

Press the reset button on the top panel with a paper clip. This will set the read and write Community names to public and private, respectively.

How can the DWL-1800 unit be returned to factory default settings?

There are two ways. One way is to use the Default button on the Station Control Tab in the DWL-1800 Configuration Utility. The other is to press and hold the reset button on the back of the unit while powering on the unit. Remember that all settings including IP addresses will be lost when setting defaults.

Management

What management options are available for the DWL-1800?

The DWL-1800/DWL-1800D comes with a graphical Configuration Utility that operates on any Windows based network ready PC. With this utility you can configure and monitor every DWL-1800 on your network. You can also use the DWL-1800 SNMP MIB on standard management platforms like SNMPc, and HP Openview.

Does the DWL-1800 offer out-of-band management?

No, the DWL-1800 does not offer out-of-band management, such as a serial port. The DWL-1800 is managed in-band only via the DWL-1800 Configuration Utility or SNMP.

What installation and site survey tools are available for DWL-1800/DWL-1800?

The DWL-1800 comes with a Windows based manager utility. With this utility you can configure link parameters and monitor signal quality and RSSI (received signal strength indication). Optimizing antenna alignment is done using the signal quality and RSSI display. Any computer on the network can use this utility to manage the DWL-1800B/DWL-1800R.

APPENDIX B. PREPARING THE INDOOR TO OUTDOOR CABLE

The Indoor-to-Outdoor cable provides pin-to-pin connection on both sides. It is supplied open-ended at both sides, to allow the installer to conveniently route the cable into the waterproof seal off the Outdoor unit and through holes in walls.

Figure 26 shows the wire pair connections required for the Indoor-to-Outdoor cable.

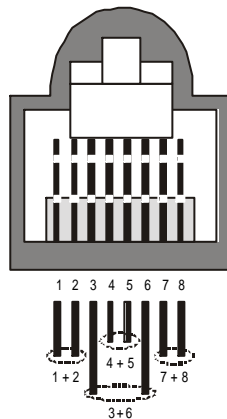

Figure 26: Ethernet Connector Pin Assignments

Use a crimp tool for RJ-45 connectors to prepare the wires, insert them into the appropriate pins and use the crimp tool to crimp the connector. Make sure to do the following:

- a) Remove as small a length as possible of the external jacket. Verify that the external jacket is well inside the service box to ensure good sealing.
- b) Take back the shield drain wire before inserting the cable into the RJ-45 connector, to ensure a good connection with the connector's shield after crimping.

APPENDIX C. RADIO SIGNAL PROPAGATION

Introduction

This section explains and simplifies many of the terms relating to antennas and RF (Radio Frequency) used when dealing with an RF installation system.

The following diagram depicts a typical radio system:

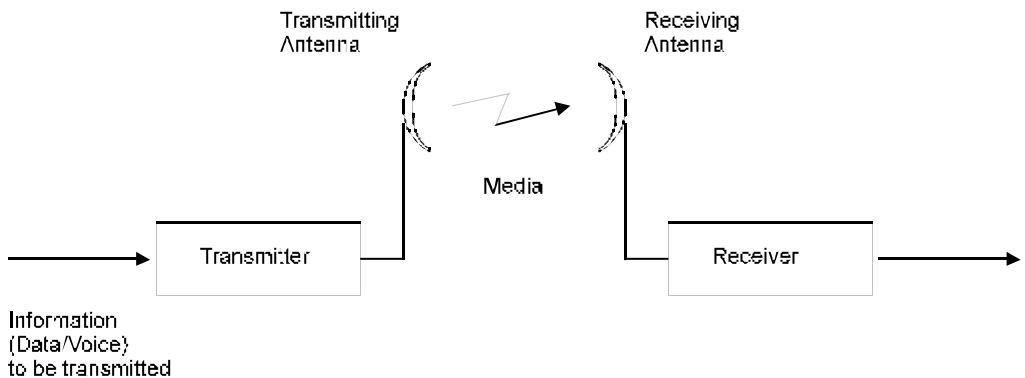

Figure 27: A Typical Radio System

A radio system transmits information to the transmitter. The information is transmitted through an antenna that converts the RF signal into an electromagnetic wave. The transmission medium for electromagnetic wave propagation is free space.

The electromagnetic wave is intercepted by the receiving antenna, which converts it back to an RF signal. Ideally, this RF signal is the same as that originally generated by the transmitter. The original information is then demodulated back to its original form.

RF Terms and Definitions

dB

The dB convention is an abbreviation for decibels. It shows the relationship between two values.

RF Power Level

RF power level at either the transmitter output or the receiver input is expressed in Watts. It can also be expressed in dBm. The relation between dBm and Watts can be expressed as follows:

$$P_{\text{dBm}} = 10 \times \text{Log } P_{\text{mW}}$$

For example: 1 Watt = 1000 mW; $P_{\text{dBm}} = 10 \times \text{Log } 1000 = 30 \text{ dBm}$
100 mW; $P_{\text{dBm}} = 10 \times \text{Log } 100 = 20 \text{ dBm}$

For link budget calculations, the dBm convention is more convenient than the Watts convention.

Attenuation

Attenuation (fading) of an RF signal is defined as follows:

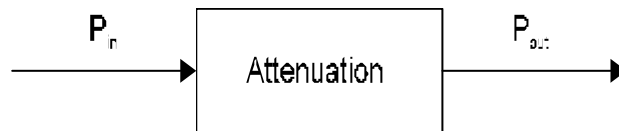

Figure 28: Attenuation of an RF signal

P_{in} is the incident power level before attenuation

P_{out} is the output power level after attenuation

Attenuation is expressed in dB as follows: $P_{\text{dB}} = -10 \times \text{Log } (P_{\text{out}}/P_{\text{in}})$

For example: If, due to attenuation, half the power is lost ($P_{\text{out}}/P_{\text{in}} = 1/2$), attenuation in dB is $-10 \times \text{Log } (1/2) = 3_{\text{dB}}$

Path Loss

Loss of power of an RF signal traveling (propagating) through space. It is expressed in dB. Path loss depends on:

- ?? The distance between transmitting and receiving antennas
- ?? Line of sight clearance between the receiving and transmitting antennas
- ?? Antenna height

Free Space Loss

Attenuation of the electromagnetic wave while propagating through space. This attenuation is calculated using the following formula:

$$\text{Free space loss} = 32.4 + 20 \times \text{Log}(F_{\text{MHz}}) + 20 \times \text{Log}(R_{\text{Km}})$$

F is the RF frequency expressed in MHz.

R is the distance between the transmitting and receiving antennas (expressed in Km).

At 2.4 GHz, this formula is: $100 + 20 \times \text{Log}(R_{\text{Km}})$

Antenna Characteristics

Isotropic Antenna

A hypothetical antenna having equal radiation intensity in all directions. Used as a zero dB gain reference in directivity calculation (gain).

Antenna Gain

A measure of directivity. It is defined as the ratio of the radiation intensity in a given direction to the radiation intensity that would be obtained if the power accepted by the antenna was radiated equally in all directions (isotropically). Antenna gain is expressed in dBi.

Radiation Pattern

A graphical representation in either polar or rectangular coordinates of the spatial energy distribution of an antenna.

Side Lobes

The radiation lobes in any direction other than that of the main lobe.

Directional Antenna

Radiates and receives most of the signal power in one direction. The following diagram shows the radiation pattern of a directional antenna with its side lobes in polar form:

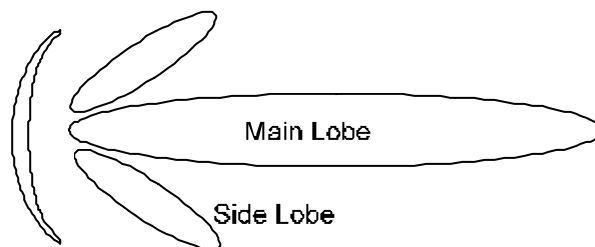

Figure 29: Radiation Pattern of Directional Antenna

Antenna Beamwidth

The directiveness of a directional antenna. Defined as the angle between two half-power (-3 dB) points on either side of the main lobe of radiation.

System Characteristics

Receiver Sensitivity

The minimum RF signal power level required at the input of a receiver for certain performance (e.g. BER).

EIRP (Effective Isotropic Radiated Power)

The antenna transmitted power. Equal to the transmitted output power minus cable loss plus the transmitting antenna gain.

P_{out} - Output power transmitted in dBm

C_t - Transmitter cable attenuation in dB

G_t - Transmitting antenna gain in dBi

G_r - Receiving antenna gain in dBi

Pl - Path loss in dB

C_r - Receiver cable attenuation in dB

S_i - Received power level at receiver input in dBm

P_s - Receiver sensitivity in dBm

$S_i = P_{out} - C_t + G_t - Pl + G_r - C_r$

$EIRP = P_{out} - C_t + G_t$

Example:

Link Parameters:

Frequency: 2.4 GHz

$P_{out} = 4$ dBm (2.5 mW)

Tx and Rx cable length (C_t and C_r) = 10 m. cable type RG214 (0.6 dB/meter)

Tx and Rx antenna gain (G_t and G_r) = 18 dBi

Distance between sites = 3 Km

Receiver sensitivity (P_s) = -84 dBm

Link Budget Calculation

$$\text{EIRP} = P_{\text{out}} - C_t + G_t = 16 \text{ dBm}$$

$$P_l = 32.4 + 20 \times \log(\text{FMHz}) + 20 \times \log(\text{RKm}) \approx 110 \text{ dB}$$

$$S_i = \text{EIRP} - P_l + G_r - C_r = -82 \text{ dBm}$$

In conclusion, the received signal power is above the sensitivity threshold, so the link should work. The problem is that there is only a 2 dB difference between received signal power and sensitivity. Normally, a higher margin is desirable due to fluctuation in received power as a result of signal fading.

Signal Fading

Fading of the RF signal is caused by several factors:

?? Multipath

The transmitted signal arrives at the receiver from different directions, with different path lengths, attenuation and delays. The summed signal at the receiver may result in an attenuated signal.

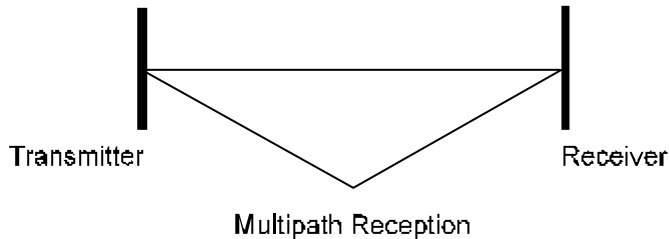

Figure 30: Multipath Reception

?? Bad Line of Sight

An optical line of sight exists if an imaginary straight line can connect the antennas on either side of the link.

Radio wave clear line of sight exists if a certain area around the optical line of sight (Fresnel zone) is clear of obstacles. A bad line of sight exists if the first Fresnel zone is obscured.

?? Distance

?? Weather conditions (rain, wind, etc.)

At high rain intensity (150 mm/hr), the fading of an RF signal at 2.4 GHz may reach a maximum of 0.02 dB/Km. Wind may cause fading due to antenna motion.

?? Interference

Interference may be caused by another system on the same frequency range, external noise, or some other co-located system.

The Line of Sight Concept

An optical line of sight exists if an imaginary straight line can be drawn connecting the antennas on either side of the link.

Clear Line of Sight

A clear line of sight exists when no physical objects obstruct viewing one antenna from the location of the other antenna.

A radio wave clear line of sight exists if a defined area around the optical line of sight (Fresnel Zone) is clear of obstacles.

Fresnel Zone

The Fresnel zone is the area of a circle around the line of sight.

The Fresnel Zone is defined as follows:

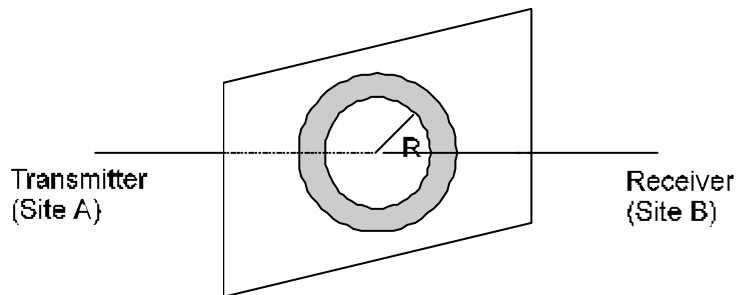

Figure31: Fresnel Zone

$$R = \frac{1}{2} \sqrt{\lambda \times D}$$

R: radius of the first Fresnel zone.

λ : wavelength (expressed in feet).

D: distance between sites (expressed in Km).

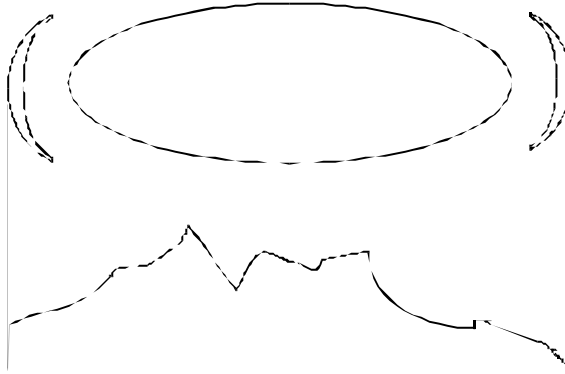

Figure 32: Fresnel Zone Clear of Obstacles

When at least 80% of the first Fresnel Zone is clear of obstacles, propagation loss is equivalent to that of free space.

FCC Warning

This equipment has been tested and found to comply with the limits for a Class B digital device, pursuant to part 15 of the FCC Rules. These limits are designed to provide reasonable protection against harmful interference in a residential installation. This equipment generates, uses and can radiate radio frequency energy and, if not installed and used in accordance with the instructions, may cause harmful interference to radio communication.

However, there is no guarantee that interference will not occur in a particular installation. If this equipment does cause harmful interference to radio or television reception, which can be determined by turning the equipment off and on, the user is encouraged to try to correct the interference by one or more of the following measures:

- Reorient or relocate the receiving antenna.
- Increase the separation between the equipment and receiver.
- Connect the equipment into an outlet on a circuit different from that to which the receiver is connected.
- Consult the dealer or an experienced radio/TV technician for help.

The Class B digital apparatus meet all requirements of the Canadian Interference-Causing Equipment Regulation.

Cet appareil numérique de la class B respecte toutes les exigences du Règlement sur le matériel brouilleur du Canada.

AVERTISSEMENT AUX UTILISATEURS

La décision N° 01-480 en date du 23 mai 2001 prise par l'Autorité de Régulation des Télécommunications (ART) autorise l'utilisation d'une partie de la bande de fréquences 2400-2483,5 MHz pour les réseaux locaux radioélectriques (RLAN)

Au niveau national, seule la bande 2446,5-2483,5 MHz est autorisée pour des produits ayant une puissance limitée à 100 mW

Cette bande de fréquences correspond aux canaux 10,11,12 et 13.

En installant et utilisant les produits réseaux sans fils de la gamme proposée par D-Link, vous vous engagez donc à respecter cette réglementation et à n'utiliser que ces 4 canaux.

WARNING

The Decision N° 01-480 taken by ART (Autorité de Régulation de Télécommunications) on May 23, 2001 authorizes the utilisation of a part of the 2400-2483.5MHz band for Radio Local Area Network (RLAN) in France.

Only the 2446.5-2483.5MHz band is authorized for RLAN with products with a limited power to 100mW.

This band concerns the channels 10, 11, 12 and 13.

Using and installing D-Link Wireless solutions for RLAN, you commit to respect this regulation et to use only these four channels.

LIMITED WARRANTY

D-Link provides this limited warranty for its product only to the person or entity who originally purchased the product from D-Link or its authorized reseller or distributor.

Limited Hardware Warranty: D-Link warrants that the hardware portion of the D-Link products described below (“Hardware”) will be free from material defects in workmanship and materials from the date of original retail purchase of the Hardware, for the period set forth below applicable to the product type (“Warranty Period”) if the Hardware is used and serviced in accordance with applicable documentation; provided that a completed Registration Card is returned to an Authorized D-Link Service Office within ninety (90) days after the date of original retail purchase of the Hardware. If a completed Registration Card is not received by an authorized D-Link Service Office within such ninety (90) period, then the Warranty Period shall be ninety (90) days from the date of purchase.

<i>Product Type</i>	<i>Warranty Period</i>
Product (excluding power supplies and fans)	One (1) Year
Power Supplies and Fans	One (1) Year
Spare parts and spare kits	Ninety (90) days

D-Link’s sole obligation shall be to repair or replace the defective Hardware at no charge to the original owner. Such repair or replacement will be rendered by D-Link at an Authorized D-Link Service Office. The replacement Hardware need not be new or of an identical make, model or part; D-Link may in its discretion may replace the defective Hardware (or any part thereof) with any reconditioned product that D-Link reasonably determines is substantially equivalent (or superior) in all material respects to the defective Hardware. The Warranty Period shall extend for an additional ninety (90) days after any repaired or replaced Hardware is delivered. If a material defect is incapable of correction, or if D-Link determines in its sole discretion that it is not practical to repair or replace the defective Hardware, the price paid by the original purchaser for the defective Hardware will be refunded by D-Link upon return to D-Link of the defective Hardware. All Hardware (or part thereof) that is replaced by D-Link, or for which the purchase price is refunded, shall become the property of D-Link upon replacement or refund.

Limited Software Warranty: D-Link warrants that the software portion of the product (“Software”) will substantially conform to D-Link’s then current functional specifications for the Software, as set forth in the applicable documentation, from the date of original delivery of the Software for a period of ninety (90) days (“Warranty Period”), if the Software is properly installed on approved hardware and operated as contemplated in its documentation. D-Link further warrants that, during the Warranty Period, the magnetic media on which D-Link delivers the Software will be free of physical defects. D-Link’s sole obligation shall be to replace the non-conforming Software (or defective media) with software that substantially conforms to D-Link’s functional specifications for the Software. Except as otherwise agreed by D-Link in writing, the replacement Software is provided only to the original licensee, and is subject to the terms and conditions of the license granted by D-Link for the Software. The Warranty Period shall extend for an additional ninety (90) days after any replacement Software is delivered. If a material non-conformance is incapable of correction, or if D-Link determines in its sole discretion that it is not practical to replace the non-conforming Software, the price paid by the original licensee for the non-conforming Software will be refunded by D-Link; provided that the non-conforming Software (and all copies thereof) is first returned to D-Link. The license granted respecting any Software for which a refund is given automatically terminates.

What You Must Do For Warranty Service:

Registration Card. The Registration Card provided at the back of this manual must be completed and returned to an Authorized D-Link Service Office for each D-Link product within ninety (90) days after the product is purchased and/or licensed. The addresses/telephone/fax list of the nearest Authorized D-Link Service Office is provided in the back of this manual. FAILURE TO PROPERLY COMPLETE AND TIMELY RETURN THE REGISTRATION CARD MAY AFFECT THE WARRANTY FOR THIS PRODUCT.

Submitting A Claim. Any claim under this limited warranty must be submitted in writing before the end of the Warranty Period to an Authorized D-Link Service Office. The claim must include a written description of the Hardware defect or Software nonconformance in sufficient detail to allow D-Link to confirm the same. The original product owner must obtain a Return Material Authorization (RMA) number from the Authorized D-Link Service Office and, if requested, provide written proof of purchase of the product (such as a copy of the dated purchase invoice for the product) before the warranty service is provided. After an RMA number is issued, the defective product must be packaged securely in the original or other suitable shipping package to ensure that it will not be damaged in transit, and the RMA number must be prominently marked on the outside of the package. The packaged product shall be insured and shipped to D-Link, 53 Discovery Drive, Irvine CA 92618, with all shipping costs prepaid. DLink may reject or return any product that is not packaged and shipped in strict compliance with the foregoing requirements, or for which an RMA number is not visible from the outside of the package. The product owner agrees to pay D-Link's reasonable handling and return shipping charges for any product that is not packaged and shipped in accordance with the foregoing requirements, or that is determined by D-Link not to be defective or non-conforming.

What Is Not Covered:

This limited warranty provided by D-Link does not cover:

Products that have been subjected to abuse, accident, alteration, modification, tampering, negligence, misuse, faulty installation, lack of reasonable care, repair or service in any way that is not contemplated in the documentation for the product, or if the model or serial number has been altered, tampered with, defaced or removed;

Initial installation, installation and removal of the product for repair, and shipping costs;

Operational adjustments covered in the operating manual for the product, and normal maintenance;

Damage that occurs in shipment, due to act of God, failures due to power surge, and cosmetic damage; and

Any hardware, software, firmware or other products or services provided by anyone other than D-Link.

Disclaimer of Other Warranties: EXCEPT FOR THE LIMITED WARRANTY SPECIFIED HEREIN, THE PRODUCT IS PROVIDED "AS-IS" WITHOUT ANY WARRANTY OF ANY KIND INCLUDING, WITHOUT LIMITATION, ANY WARRANTY OF MERCHANTABILITY, FITNESS FOR A PARTICULAR PURPOSE AND NON-INFRINGEMENT. IF ANY IMPLIED WARRANTY CANNOT BE DISCLAIMED IN ANY TERRITORY WHERE A PRODUCT IS SOLD, THE DURATION OF SUCH IMPLIED WARRANTY SHALL BE LIMITED TO NINETY (90) DAYS. EXCEPT AS EXPRESSLY COVERED UNDER THE LIMITED WARRANTY PROVIDED HEREIN, THE ENTIRE RISK AS TO THE QUALITY, SELECTION AND PERFORMANCE OF THE PRODUCT IS WITH THE PURCHASER OF THE PRODUCT.

Limitation of Liability: TO THE MAXIMUM EXTENT PERMITTED BY LAW, D-LINK IS NOT LIABLE UNDER ANY CONTRACT, NEGLIGENCE, STRICT LIABILITY OR OTHER LEGAL OR EQUITABLE THEORY FOR ANY LOSS OF USE OF THE PRODUCT, INCONVENIENCE OR DAMAGES OF ANY CHARACTER, WHETHER DIRECT, SPECIAL, INCIDENTAL OR CONSEQUENTIAL (INCLUDING, BUT NOT LIMITED TO, DAMAGES FOR LOSS OF GOODWILL, WORK STOPPAGE, COMPUTER FAILURE OR MALFUNCTION, LOSS OF INFORMATION OR DATA CONTAINED IN, STORED ON, OR INTEGRATED WITH ANY PRODUCT RETURNED TO D-LINK FOR WARRANTY SERVICE) RESULTING FROM THE USE OF THE PRODUCT, RELATING TO WARRANTY SERVICE, OR ARISING OUT OF ANY BREACH OF THIS LIMITED WARRANTY, EVEN IF D-LINK HAS BEEN ADVISED OF THE POSSIBILITY OF SUCH DAMAGES. THE SOLE REMEDY FOR A BREACH OF THE FOREGOING LIMITED WARRANTY IS REPAIR, REPLACEMENT OR REFUND OF THE DEFECTIVE OR NON-CONFORMING PRODUCT.

GOVERNING LAW: This Limited Warranty shall be governed by the laws of the state of California.

Some states do not allow exclusion or limitation of incidental or consequential damages, or limitations on how long an implied warranty lasts, so the foregoing limitations and exclusions may not apply. This limited warranty provides specific legal rights and the product owner may also have other rights which vary from state to state.

Trademarks

Copyright © 1999 D-Link Corporation. Contents subject to change without prior notice. D-Link is a registered trademark of D-Link Corporation/D-Link Systems, Inc. All other trademarks belong to their respective proprietors.

Copyright Statement

No part of this publication may be reproduced in any form or by any means or used to make any derivative such as translation, transformation, or adaptation without permission from D-Link Corporation/D-Link Systems Inc., as stipulated by the United States Copyright Act of 1976.

D-Link Offices

AUSTRALIA	D-LINK AUSTRALIA Unit 16, 390 Eastern Valley Way, Roseville, NSW 2069, Australia TEL: 61-2-9417-7100 FAX: 61-2-9417-1077 TOLL FREE: 1800-177-100 (Australia), 0800-900900 (New Zealand) E-MAIL: support@dlink.com.au, info@dlink.com.au URL: www.dlink.com.au
BENELUX	D-LINK BENELUX Fellenoord 130, 5611 ZB Eindhoven, The Netherlands TEL: 31-40-2668713 FAX: 31-40-2668666 E-MAIL: info@dlink-benelux.nl, info@dlink-benelux.be URL: www.dlink-benelux.nl , www.dlink-benelux.be
CANADA	D-LINK CANADA #2180 Winston Park Drive, Oakville, Ontario, L6H 5W1 Canada TEL: 1-905-829-5033 FAX: 1-905-829-5095 FREE CALL: 1-800-354-6522 E-MAIL: techsup@dlink.ca URL: www.dlink.ca FTP: ftp.dlinknet.com
CHILE	D-LINK SOUTH AMERICA Isidora Goyechea 2934 of 702, Las Condes, Santiago - Chile S.A. TEL: 56-2-232-3185 FAX: 56-2-232-0923 E-MAIL: cecasassu@dlink.cl, tsilva@dlink.cl URL: www.dlink.cl
CHINA	D-LINK CHINA 2F, Sigma Building, 49 Zhichun Road, Haidian District, 100080 Beijing, China TEL: 86-10-85182533 FAX: 86-10-85182250
DENMARK	D-LINK DENMARK Naverland 2, DK-2600 Glostrup, Copenhagen, Denmark TEL: 45-44-96800 FAX: 45-44-424347 E-MAIL: info@dlink.dk URL: www.dlink.dk
EGYPT	D-LINK MIDDLE EAST 7 Assem Ebn Sabet Street, Heliopolis Cairo, Egypt TEL: 202-2456176 FAX: 202-2456192 E-MAIL: support@dlink-me.com URL: www.dlink-me.com
FINLAND	D-Link FINLAND Thlli-ja Pakkahuone Kataljanokanlaituri 5, FIN-00160 Helsinki, Finland TEL: 358-9-422-611660 FAX: 358-9-622-91661 E-MAIL: info@dlink.fi.com URL: www.dlink.fi.com
FRANCE	D-LINK FRANCE Le Florilege #2, Allée de la Fresnerie, 78330 Fontenay le Fleury France TEL: 33-1-302-38688 FAX: 33-1-3023-8689 E-MAIL: info@dlink-france.fr URL: www.dlink-france.fr
GERMANY	D-LINK Central Europe/D-Link Deutschland GmbH Schwalbacher Strasse 74, D-65760 Eschborn, Germany TEL: 49-6196-77990 FAX: 49-6196-7799300 INFO LINE: 00800-7250-0000 (toll free) HELP LINE: 00800-7250-4000 (toll free) REPAIR LINE: 00800-7250-8009 E-MAIL: info@dlink.de URL: www.dlink.de
IBERIA	D-LINK IBERIA Gran Via de Carlos III, 84, 3º Edificio Trade, 08028 BARCELONA TEL: 34 93 4090770 FAX: 34 93 4910785 E-MAIL: info@dlinkiberia.es URL: www.dlinkiberia.es
INDIA	D-LINK INDIA Plot No.5, Kurla-Bandra Complex Road, Off Cst Road, Santacruz (E), Bombay - 400 098 India TEL: 91-22-652-6696 FAX: 91-22-652-8914 E-MAIL: service@dlink.india.com URL: www.dlink-india.com
ITALY	D-LINK ITALIA Via Nino Bonnet No. 6/b, 20154 Milano, Italy TEL: 39-02-2900-0676 FAX: 39-02-2902-1723 E-MAIL: info@dlink.it URL: www.dlink.it
JAPAN	D-LINK JAPAN 10F, 8-8-15 Nishi-Gotanda, Shinagawa-ku, Tokyo 141, Japan TEL: 81-3-434-9678 FAX: 81-3-5434-9868 E-MAIL: kida@d-link.co.jp URL: www.d-link.co.jp
NORWAY	D-LINK NORWAY Waldemar Thranesgt. 77, 0175 Oslo, Norway TEL: 47-22-991890 FAX: 47-22-207039
RUSSIA	D-LINK RUSSIA Michurinski Prospekt 49, 117607 Moscow, Russia TEL: 7-095-737-3489 7-095-737-3492 FAX: 7-095-737-3390 E-MAIL: vl@dlink.ru URL: www.dlink.ru
SINGAPORE	D-LINK INTERNATIONAL 1 International Business Park, #03-12 The Synergy, Singapore 609917 TEL: 65-774-6293 FAX: 65-774-6322 E-MAIL: info@dlink.com.sg URL: www.dlink-intl.com
S. AFRICA	D-LINK SOUTH AFRICA 102-106 Witchhazel Avenue, Einetain Park 2, Block B, Highveld Technopark Centurion, South Africa TEL: 27(0)126652165 FAX: 27(0)126652186 E-MAIL: atl@e-d-link.co.za URL: www.d-link.co.za
SWEDEN	D-LINK SWEDEN P.O. Box 15036, S-167 15 Bromma Sweden TEL: 46-(0)8564-61900 FAX: 46-(0)8564-61901 E-MAIL: info@dlink.se URL: www.dlink.se
TAIWAN	D-LINK TAIWAN 2F, No. 119 Pao-Chung Road, Hsin-Tien, Taipei, Taiwan TEL: 886-2-2910-2626 FAX: 886-2-2910-1515 E-MAIL: ds@tsc.dlinktw.com.tw URL: www.dlinktw.com.tw
UK	D-LINK EUROPE 4th Floor, Merit House, Edgware Road, Colindale, London, NW9 5AB, U.K. TEL: 44-20-8731-5555 FAX: 44-20-8731-5511 E-MAIL: info@dlink.co.uk URL: www.dlink.co.uk
USA.	D-LINK U.S.A. 53 Discovery Drive, Irvine, CA 92618 USA TEL: 1-949-788-0805 FAX: 1-949-753-7033 INFO LINE: 1-877-453-5465 BBS: 1-949-455-1779, 1-949-455-9616 E-MAIL: tech@dlink.com, support@dlink.com URL: www.dlink.com

Registration Card

Print, type or use block letters.

Your name: Mr./Ms _____
 Organization: _____ Dept. _____
 Your title at organization: _____
 Telephone: _____ Fax: _____
 Organization's full address: _____

 Country: _____
 Date of purchase (Month/Day/Year): _____

Product Model	Product Serial No.	* Product installed in type of computer (e.g., Compaq 486)	* Product installed in computer serial No.

(* Applies to adapters only)

Product was purchased from:

Reseller's name: _____
 Telephone: _____ Fax: _____
 Reseller's full address: _____

Answers to the following questions help us to support your product:

- 1. Where and how will the product primarily be used?**
 Home Office Travel Company Business Home Business Personal Use
- 2. How many employees work at installation site?**
 1 employee 2-9 10-49 50-99 100-499 500-999 1000 or more
- 3. What network protocol(s) does your organization use ?**
 XNS/IPX TCP/IP DECnet Others _____
- 4. What network operating system(s) does your organization use ?**
 D-Link LANsmart Novell NetWare NetWare Lite SCO Unix/Xenix PC NFS 3Com 3+Open
 Banyan Vines DECnet Pathwork Windows NT Windows NTAS Windows '95
 Others _____
- 5. What network management program does your organization use ?**
 D-View HP OpenView/Windows HP OpenView/Unix SunNet Manager Novell NMS
 NetView 6000 Others _____
- 6. What network medium/media does your organization use ?**
 Fiber-optics Thick coax Ethernet Thin coax Ethernet 10BASE-T UTP/STP
 100BASE-TX 100BASE-T4 100VGAnyLAN Others _____
- 7. What applications are used on your network?**
 Desktop publishing Spreadsheet Word processing CAD/CAM
 Database management Accounting Others _____
- 8. What category best describes your company?**
 Aerospace Engineering Education Finance Hospital Legal Insurance/Real Estate Manufacturing
 Retail/Chainstore/Wholesale Government Transportation/Utilities/Communication VAR
 System house/company Other _____
- 9. Would you recommend your D-Link product to a friend?**
 Yes No Don't know yet
- 10. Your comments on this product?**

PLEASE
PLACE STAMP
HERE

TO:

D-Link®