



Quick Installation Guide

Full HD PoE/Wireless N Cube Network Camera

This document will guide you through the basic installation process for your new D-Link Network Camera.

DCS-2210/DCS-2230

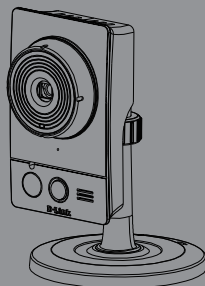

Quick Installation Guide
Installationsanleitung
Guide d'installation
Guía de instalación
Guida di Installazione

Documentation also available on
CD and via the D-Link Website

DCS-2210/DCS-2230 Quick Install Guide

This installation guide provides basic instructions for installing the DCS-2210/DCS-2230 Network Camera on your network. For additional information about how to use the camera, please see the User's Manual which is available on the CD include in this package or from the D-Link support website.

Installation Steps

1. Verify the package contents against the list below.
2. Hardware Overview
3. Hardware Installation
4. Configuration with Wizard

1. Package Contents

- DCS-2210/DCS-2230 Network Camera
- Camera Stand
- Manual and Software on CD-ROM
- CAT5 Ethernet Cable
- Power Adapter
- Quick Install Guide

If any of the above items are missing, please contact your reseller.

2. Hardware Overview

Rear Panel

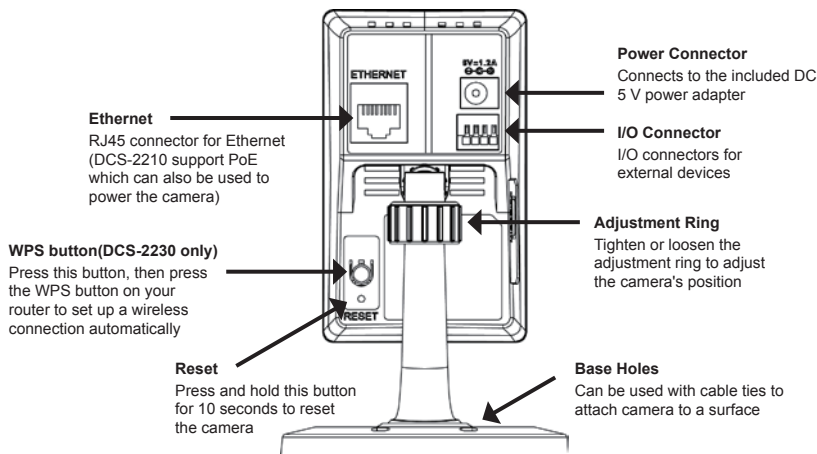

Front Panel

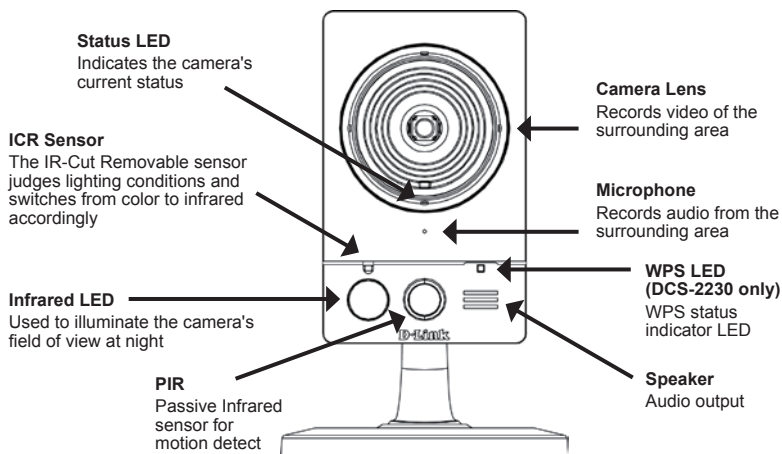

Left Panel

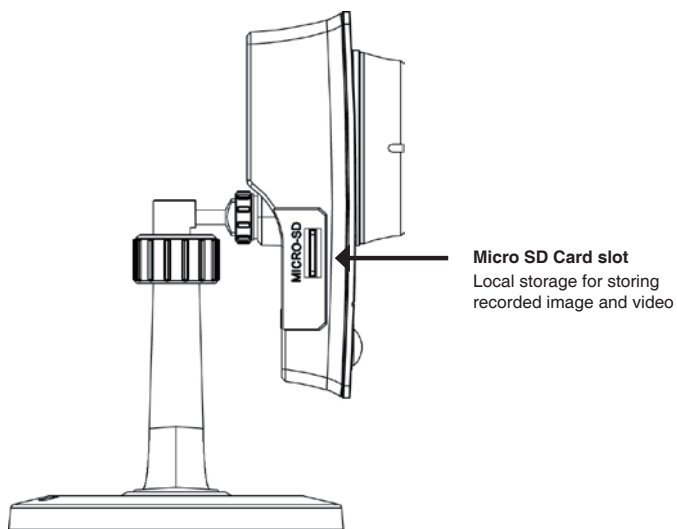

3. Hardware Installation

Basic Connection

Connect the camera to your switch or router via Ethernet cable.
Connect the supplied power cable from the camera to a power outlet.

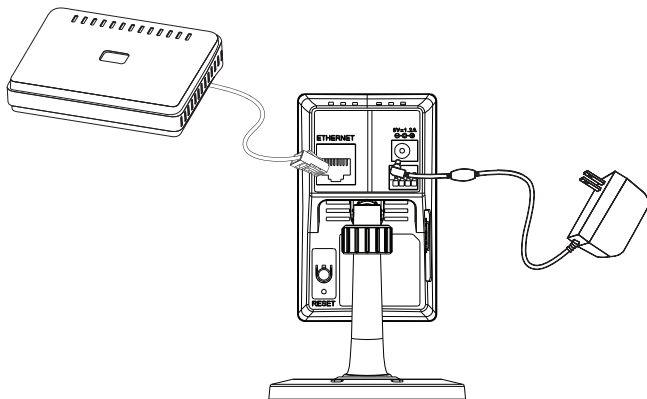

Connection Using a PoE Switch (DCS-2210 only)

If using a PoE switch or router, connect the network camera via Ethernet cable.
PoE will transmit both power and data over a single cable.

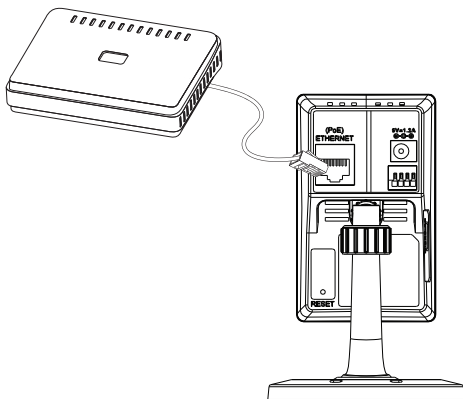

Note: Once power has been established, the LED will turn red. When the device has obtained an IP address and is accessible, the LED will turn green.

4. Configuration with Wizard

Insert the DCS-2210/DCS-2230 CD into your computer's CD-ROM drive to begin the installation. If the Autorun function on your computer is disabled, or if the D-Link Launcher fails to start automatically, click **Start > Run**. Type **D:\autorun.exe**, where D: represents the drive letter of your CD-ROM drive.

Click **Setup Wizard** to begin the installation.



After clicking Setup Wizard, the following window will open.

Click **Next** to continue.

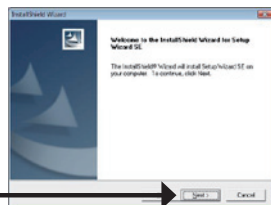

Click **Yes** to accept the License Agreement.

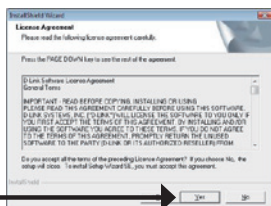

To start the installation process, click **Next**.

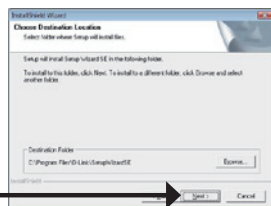

Note: The installation may take several minutes to finish.

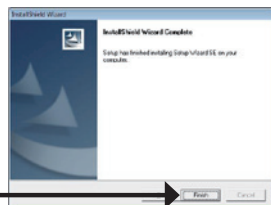

Click **Finish** to complete the installation.

Click on the **D-Link Setup Wizard SE** icon that was created in your Windows Start menu.

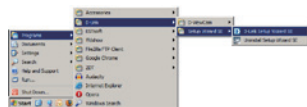

Start > D-Link > Setup Wizard SE

The Setup Wizard will appear and display the MAC address and IP address of your camera(s). If you have a DHCP server on your network, a valid IP Address will be displayed. If your network does not use a DHCP server, the network camera's default static IP **192.168.0.20** will be displayed.

Click the **Wizard** button to continue.



Enter the Admin ID and password. When logging in for the first time, the default Admin ID is **admin** with the password left blank.

Click **Next**, to proceed to the next page.

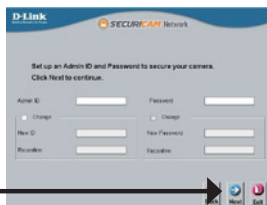

Select DHCP if your camera obtains an IP address automatically when it boots up. Select static IP if the camera will use the same IP address each time it is started.

Click **Next**, to proceed to the next page.



Take a moment to confirm your settings and click **Restart**.

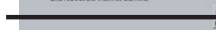

Viewing Camera via Web Browser

Click on the **D-Link Setup Wizard SE** icon that was created in your Windows Start menu.

Start > D-Link > Setup Wizard SE

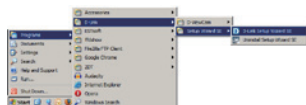

Select the camera and click the button labeled "**Link**" to access the web configuration.

The Setup Wizard will automatically open your web browser to the IP address of the camera.



Enter **admin** as the default username and leave the password blank. Click **OK** to continue.



This section shows your camera's live video. You can select your video profile and view or operate the camera. For additional information about web configuration, please refer to the user manual included on the CD-ROM or the D-Link website.



Technical Support

United Kingdom (Mon-Fri) website: <http://www.dlink.co.uk> FTP: <ftp://ftp.dlink.co.uk>
Home Wireless/Broadband 0871 873 3000 (9.00am–06.00pm, Sat 10.00am-02.00pm)
Managed, Smart, & Wireless Switches, or Firewalls 0871 873 0909 (09.00am- 05.30pm)
(BT 10ppm, other carriers may vary.)

Ireland (Mon-Fri)

All Products 1890 886 899 (09.00am-06.00pm, Sat 10.00am-02.00pm)
Phone rates: €0.05ppm peak, €0.045ppm off peak times

DCS-2210/DCS-2230 Installationsanleitung

Diese Installationsanleitung bietet Ihnen grundlegende Anleitungen zur Installation der DCS-2210/DCS-2230 Netzwerkkamera in Ihrem Netzwerk. Zusätzliche Informationen zur Verwendung der Kamera finden Sie im Benutzerhandbuch, das Ihnen auf der CD, die diesem Paket beiliegt, oder über die D-Link Support-Website zur Verfügung steht.

Installationschritte

1. Vergewissern Sie sich, dass der Packungsinhalt mit den Angaben auf der Liste unten übereinstimmt.
2. Hardware-Überblick
3. Hardware-Installation
4. Konfiguration mithilfe des Assistenten

1. Packungsinhalt

- DCS-2210/DCS-2230 Netzwerkkamera
- Kamerafuß
- Handbuch und Software auf der CD-ROM
- Kat.5 Ethernetkabel
- Stromadapter
- Installationsanleitung

Sollte einer der oben aufgeführten Artikel fehlen, wenden Sie sich bitte an Ihren Fachhändler.

2. Hardware-Überblick

Rückseite

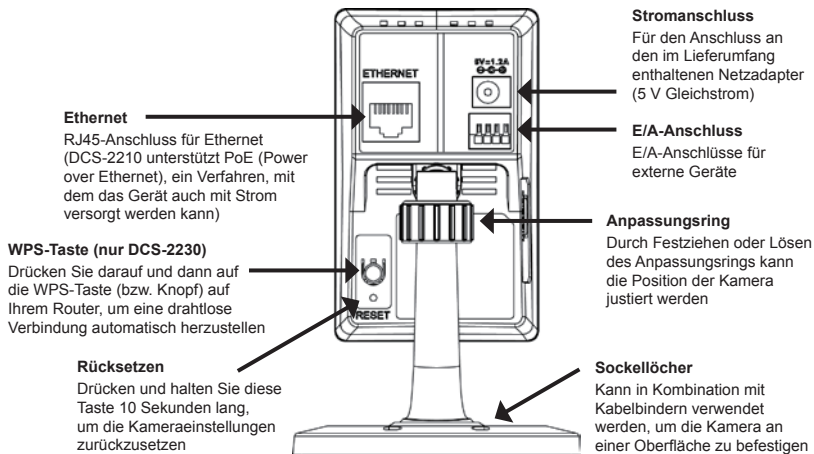

Vorderseite

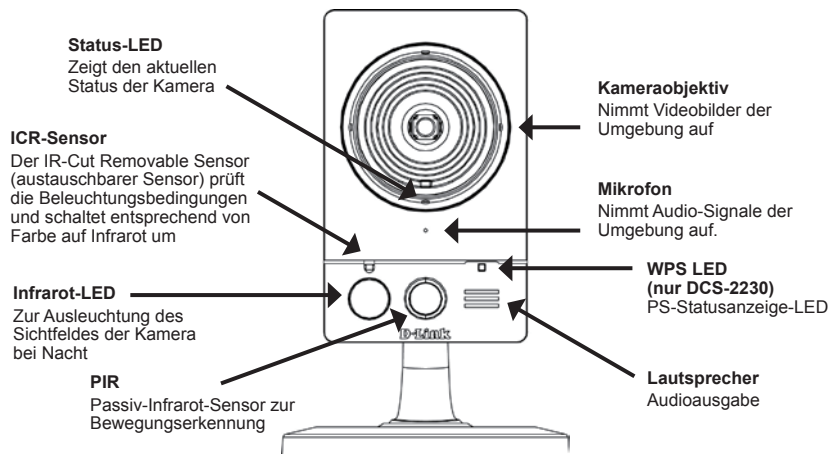

Linke Seite

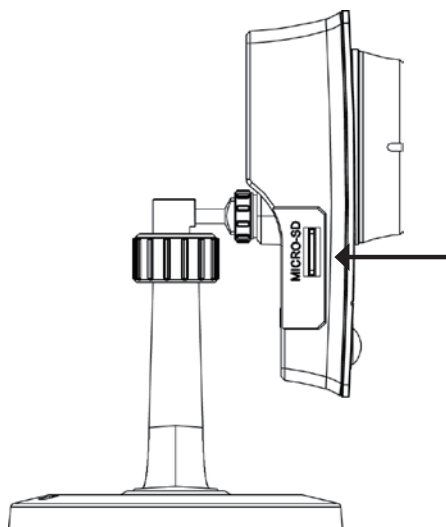

MicroSD-Karten-Steckplatz

Lokaler Speicher zum Speichern von Bildern und Videoaufnahmen

3. Hardware-Installation

Allgemeine Verbindung

Schließen Sie die Kamera über das Ethernetkabel an Ihren Switch oder Router an. Schließen Sie die Kamera mit dem mitgelieferten Stromkabel an eine Steckdose an.

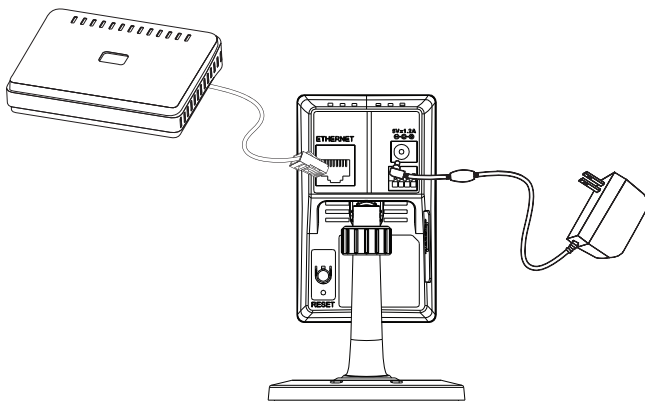

Anschluss mit einem PoE Switch (DCS-2210 only)

Wenn Sie einen PoE-Switch oder Router verwenden, schließen Sie die Netzwerkkamera über das Ethernetkabel an.

PoE (Power over Ethernet) liefert sowohl Strom als auch Daten über ein einziges Kabel.

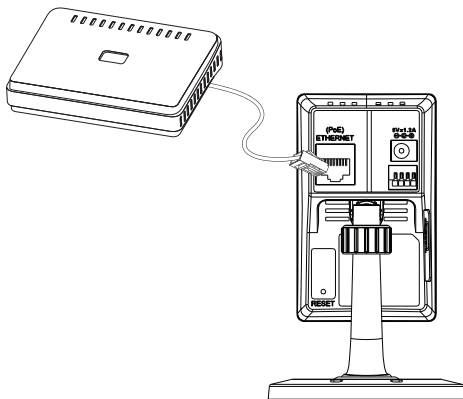

Hinweis: Sobald die Stromzufuhr hergestellt ist, leuchtet die LED rot auf. Wenn das Gerät dann eine IP-Adresse erhalten hat und darauf zugegriffen werden kann, leuchtet die LED grün.

4. Konfiguration mithilfe des Assistenten

Legen Sie die DCS-2210/DCS-2230 CD in das CD-ROM-Laufwerk Ihres Computers, um die Installation zu beginnen. Ist die Funktion zur automatischen Ausführung auf Ihrem Computer deaktiviert oder das D-Link-Startprogramm startet nicht automatisch, klicken Sie auf **Start > Ausführen**. Geben Sie **D:\autorun.exe** ein, wobei D: für den Laufwerkbuchstaben Ihres CD-ROM-Laufwerks steht.

Klicken Sie auf **Setup Wizard** (Installationsassistent), um die Installation zu starten.



Nachdem Sie auf 'Setup Wizard' (Setup-Assistent) geklickt haben, wird das folgende Fenster geöffnet.

Klicken Sie auf **Next** (Weiter), um fortzufahren.

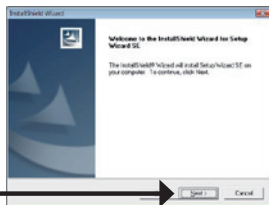

Klicken Sie auf **Yes (Ja)**, um die Lizenzvereinbarung zu akzeptieren.

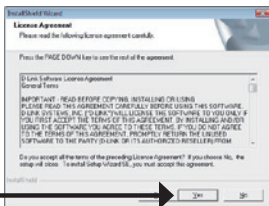

Um den Installationsprozess zu starten, klicken Sie auf **Next** (Weiter).

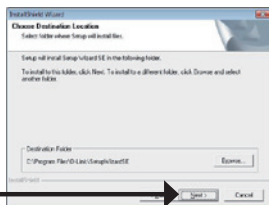

Hinweis: Der Installationsvorgang kann mehrere Minuten dauern.

Klicken Sie auf **Finish** (Fertig stellen), um die Installation abzuschließen.

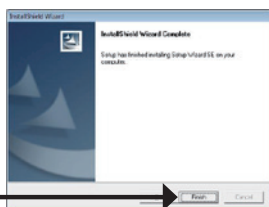

Klicken Sie auf das Symbol für den **D-Link Setup-Assistenten SE**, das in Ihrem Windows-Startmenü erstellt wurde.

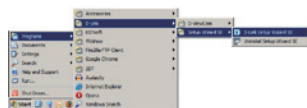

Start > D-Link > Setup Wizard SE

Der Setup-Assistent wird aufgerufen und zeigt die MAC-Adresse und die IP-Adresse Ihrer Kamera(s) an. Wenn in Ihrem Netzwerk ein DHCP-Server vorhanden ist, wird hier eine gültige IP-Adresse angezeigt. Wird in Ihrem Netzwerk kein DHCP-Server verwendet, wird die standardmäßige statische IP-Adresse der Netzwerkkamera **192.168.0.20** angezeigt.

Klicken Sie auf die Schaltfläche **Wizard** (Assistent), um fortzufahren.



Geben Sie die Administratorkennung und das Kennwort ein. Wenn Sie sich zum ersten Mal anmelden, ist die standardmäßig vorgegebene Administratorkennung **admin**. Lassen Sie das Feld für das Kennwort leer.

Klicken Sie auf **Next** (Weiter), um die nächste Seite anzuzeigen.

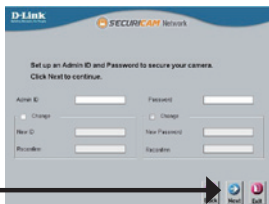

Wählen Sie die Option **DHCP**, wenn Ihre Kamera beim Hochfahren automatisch eine IP-Adresse erhält. Wählen Sie die Option **Static IP** (Statische IP), wenn die Kamera bei jedem Start die gleiche IP-Adresse verwendet.

Klicken Sie auf **Next** (Weiter), um die nächste Seite anzuzeigen.



Bestätigen Sie Ihre Einstellungen und klicken Sie auf **Restart** (Neu starten).



Die Kamera über einen Webbrowser anzeigen

Klicken Sie auf das Symbol für den **D-Link Setup-Assistenten SE**, das in Ihrem Windows-Startmenü erstellt wurde.

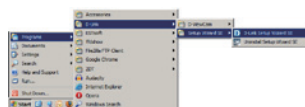

Start > D-Link > Setup Wizard SE

Wählen Sie die Kamera aus und klicken Sie auf die Schaltfläche **Link**, um auf die Web-Konfiguration zuzugreifen.



Der Setup-Assistent öffnet automatisch Ihren Webbrowser mit der IP-Adresse der Kamera.

Geben Sie als Standard-Benutzernamen **admin** ein und lassen Sie das Feld 'Password' (Kennwort) leer. Klicken Sie auf **OK**, um fortzufahren.

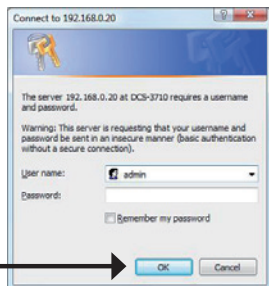

In diesem Abschnitt werden Live Videoaufnahmen Ihrer Kamera angezeigt. Sie können Ihr Videoprofil und Ihre Ansicht wählen oder die Kamera bedienen. Weitere Informationen zur Web-Konfiguration finden Sie im Benutzerhandbuch auf der CD-ROM oder auf der D-Link-Website.



Technischer Support

Deutschland: Web: <http://www.dlink.de>

Telefon: +49(0)1805 2787 0,14 € pro Minute Zeiten: Mo. –Fr. 09:00 – 17:30 Uhr

Österreich: Web: <http://www.dlink.at>

Telefon: +43(0)820 480084 0,116 € pro Minute Zeiten: Mo. –Fr. 09:00 – 17:30 Uhr

Schweiz: Web: <http://www.dlink.ch>

Telefon: +41(0)848 331100 0,08 CHF pro Minute Zeiten: Mo. –Fr. 09:00 – 17:30 Uhr

* Gebühren aus Mobilnetzen und von anderen Providern können abweichen.

Guide d'installation rapide de DCS-2210/DCS-2230

Ce guide d'installation fournit des instructions élémentaires qui vous aideront à installer la caméra réseau DCS-2210/DCS-2230 sur votre réseau. Pour obtenir des informations complémentaires sur l'utilisation de la caméra, consultez le Manuel d'utilisation, disponible sur le CD joint à ce coffret, ou sur le site Web d'assistance D-Link.

Procédure d'installation

1. Vérifiez le contenu de la boîte par rapport à la liste ci-dessous.
2. Description du matériel
3. Installation du matériel
4. Configuration à l'aide de l'assistant

1. Contenu de la boîte

- Caméra réseau DCS-2210/DCS-2230
- Support de la caméra
- Manuel et logiciel sur CD-ROM
- Câble Ethernet CAT5
- Adaptateur secteur
- Guide d'installation rapide

Contactez immédiatement votre revendeur s'il manque l'un des éléments ci-dessus.

2. Description du matériel

Panneau arrière

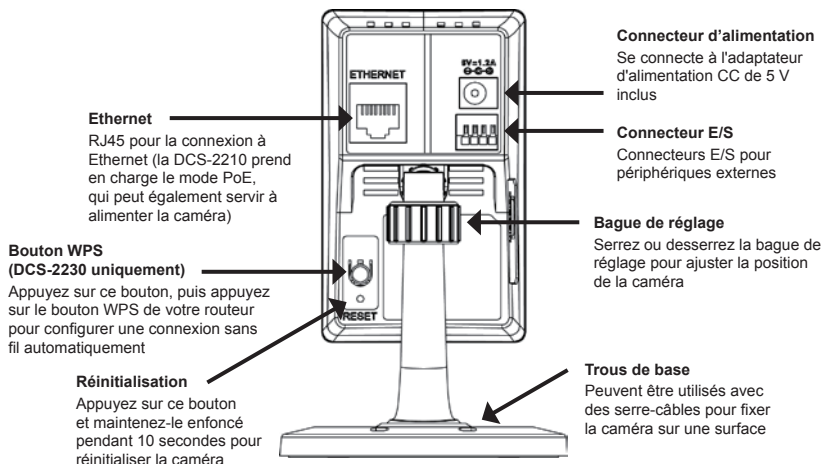

Façade

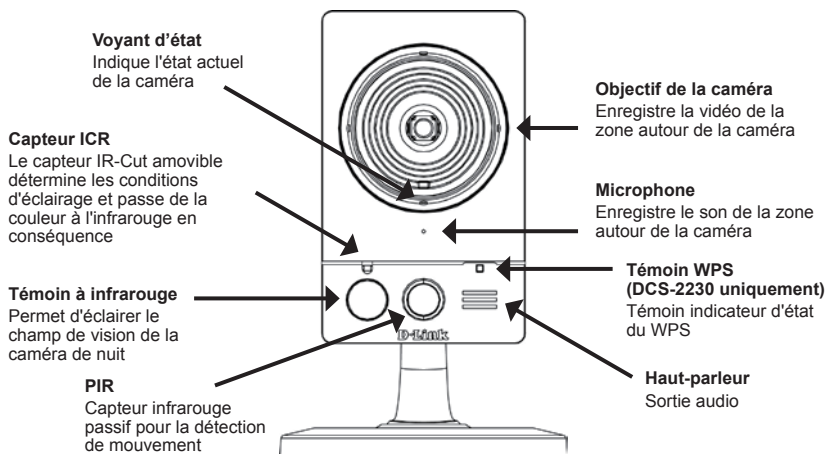

Panneau gauche

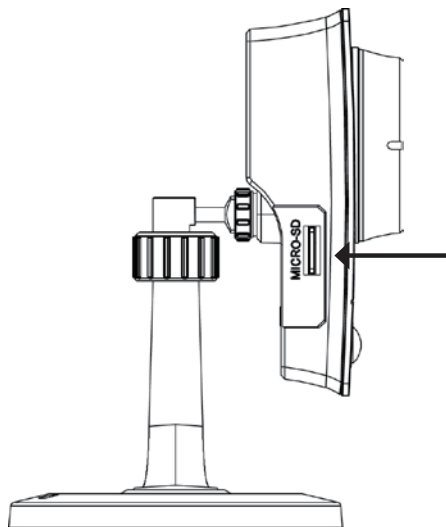

Port de carte Micro SD
Stockage local d'images et vidéos enregistrées

3. Installation du matériel

Connexion de base

Connectez la caméra à votre commutateur ou routeur via le câble Ethernet. Branchez le câble d'alimentation fourni à la caméra et à une prise secteur.

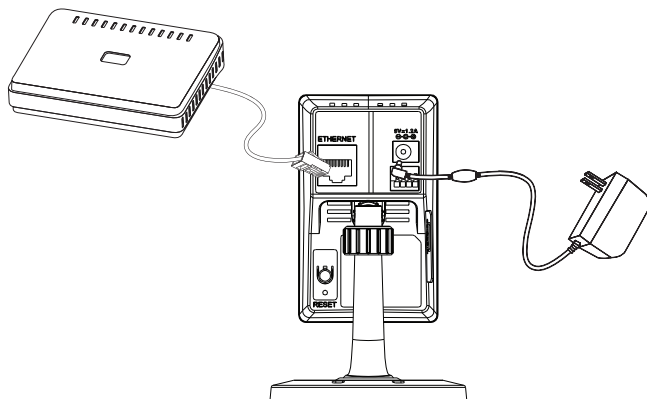

Connexion à l'aide d'un commutateur PoE (DCS-2210 only)

Si vous utilisez un commutateur ou un routeur PoE, branchez la caméra réseau par l'intermédiaire d'un câble Ethernet.

La fonction PoE servira à transmettre l'alimentation et les données par un seul câble.

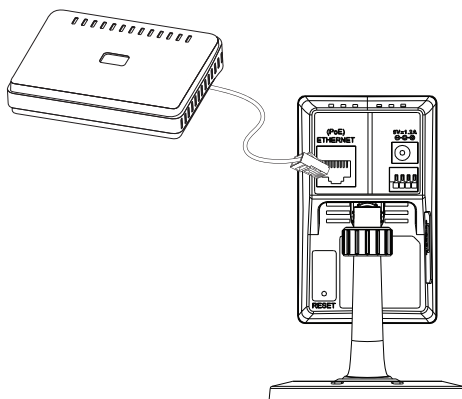

Remarque : Une fois l'alimentation établie, le voyant devient rouge. Lorsque le périphérique a obtenu une adresse IP et qu'il est accessible, ce voyant devient vert.

4. Configuration à l'aide de l'assistant

Insérez le CD de la DCS-2210/DCS-2230 dans le lecteur de CD-ROM de l'ordinateur pour lancer l'installation. Si la fonction d'exécution automatique de votre ordinateur est désactivée ou si le dispositif de lancement D-Link ne parvient pas à démarrer automatiquement, cliquez sur **Démarrer > Exécuter**. Saisissez **D:\autorun.exe** (D: représentant la lettre de lecteur de votre CD-ROM).

Cliquez sur **Setup Wizard** (Assistant d'installation) pour lancer l'installation.



Après avoir cliqué sur l'Assistant de configuration, la fenêtre suivante s'ouvre.

Cliquez sur **Next** (Suivant) pour continuer.

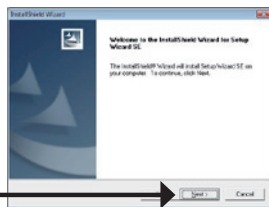

Cliquez sur **Yes** (Oui) pour accepter l'Accord de licence.

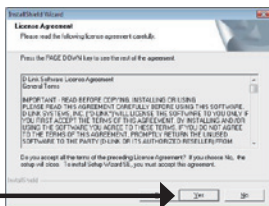

Pour lancer l'installation, cliquez sur **Next** (Suivant).

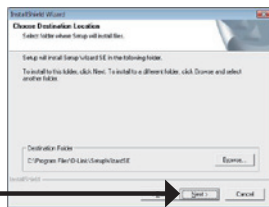

Remarque : L'installation peut prendre quelques minutes.

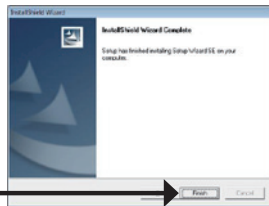

Cliquez sur **Finish** (Terminer) pour terminer l'installation.

Cliquez sur l'icône **D-Link Setup Wizard SE** (Assistant de configuration D-Link SE) créée dans le menu Démarrer.

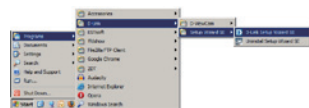

Démarrer > D-Link > Setup Wizard SE (Assistant de configuration SE)

L'Assistant de configuration s'ouvre et affiche les adresses MAC et IP de votre ou vos caméras. Si un serveur DHCP se trouve sur votre réseau, une adresse IP valide s'affiche. Si votre réseau n'utilise pas de serveur DHCP, l'adresse IP statique par défaut de la caméra réseau (**192.168.0.20**) s'affiche.

Cliquez sur **Wizard** (Assistant) pour continuer.



Saisissez l'ID administrateur et le mot de passe. Lorsque vous vous connectez pour la première fois, l'ID administrateur par défaut est **admin** et le mot de passe est vierge.

Cliquez sur **Next** (Suivant) pour passer à la page suivante.



Sélectionnez l'option **DHCP** si la caméra obtient une adresse IP automatiquement au démarrage. Sélectionnez l'option **Static IP** (Adresse IP statique) si la caméra utilise la même adresse IP à chaque démarrage.

Cliquez sur **Next** (Suivant) pour passer à la page suivante.



Prenez le temps de vérifier vos paramètres, puis cliquez sur **Restart** (Redémarrer).



Affichage de la caméra dans un navigateur Web

Cliquez sur l'icône **D-Link Setup Wizard SE** (Assistant de configuration D-Link SE) créée dans le menu Démarrer.

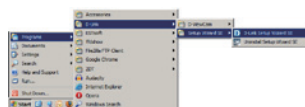

Démarrer > D-Link > Setup Wizard SE (Assistant de configuration SE)

Sélectionnez la caméra, puis cliquez sur le bouton « **Link** » (Connexion) pour accéder à la configuration Web.



L'Assistant de configuration ouvre automatiquement votre navigateur Web à l'adresse IP de la caméra.



Saisissez **admin** comme nom d'utilisateur par défaut et laissez le mot de passe vide. Cliquez sur **OK** pour continuer.

Cette section présente la vidéo en direct de votre caméra. Vous pouvez sélectionner votre profil vidéo et voir ou utiliser la caméra. Pour obtenir des informations complémentaires sur la configuration Web, reportez-vous au manuel d'utilisation du CD-ROM ou sur le site Web D-Link.



Support technique

Assistance technique D-Link sur internet : <http://www.dlink.fr>

Assistance technique D-Link par téléphone : 0820 0803 03

0.12 € TTC/min depuis un poste fixe

Du lundi au vendredi de 9h à 19h (hors jours fériés)

Guía rápida de instalación de DCS-2210/DCS-2230

Esta guía de instalación proporciona instrucciones básicas para la instalación de la cámara de red DCS-2210/DCS-2230 en su red. Para obtener información adicional acerca de cómo utilizar la cámara, consulte el Manual del usuario disponible en el CD incluido en el paquete o en el sitio web de asistencia de D-Link.

Pasos para la instalación

1. Verifique el contenido de la caja con la lista que aparece a continuación.
2. Descripción general del hardware
3. Instalación del hardware
4. Configuración con el asistente

1. ¿Qué contiene la caja?

- Cámara de red DCS-2210/DCS-2230
- Soporte de la cámara
- Manual y software en CD-ROM
- Cable Ethernet CAT5
- Adaptador de alimentación
- Guía de instalación rápida

Si falta cualquiera de los componentes anteriores, póngase en contacto con el proveedor.

2. Descripción general del hardware

Panel posterior

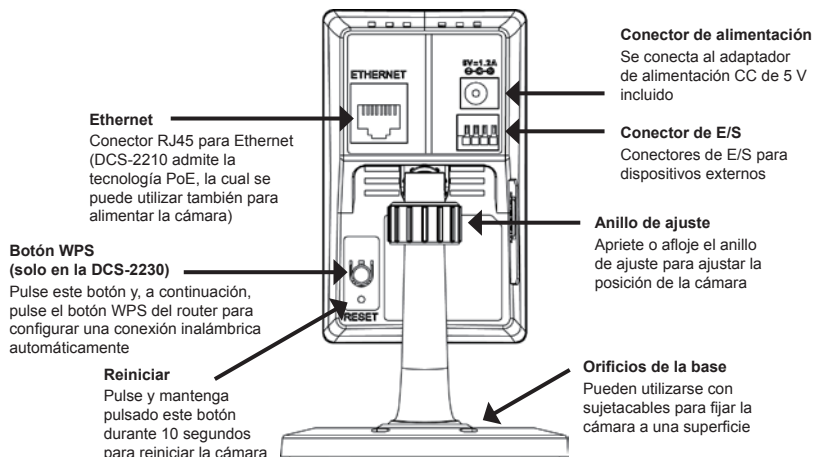

Panel frontal

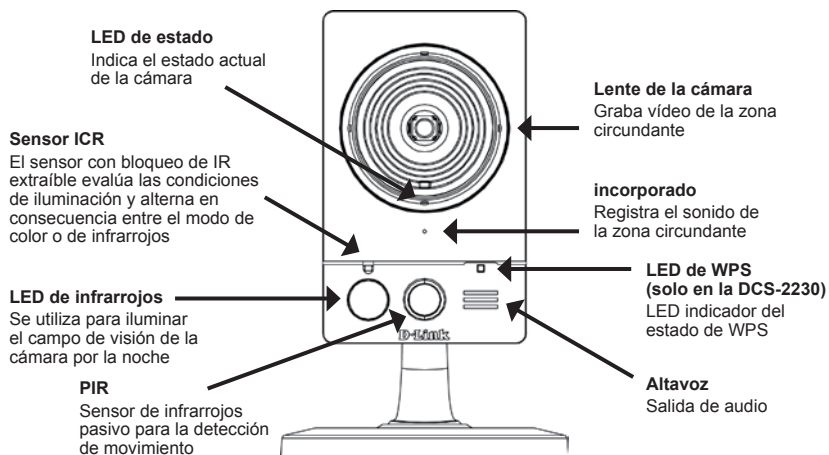

Panel izquierdo

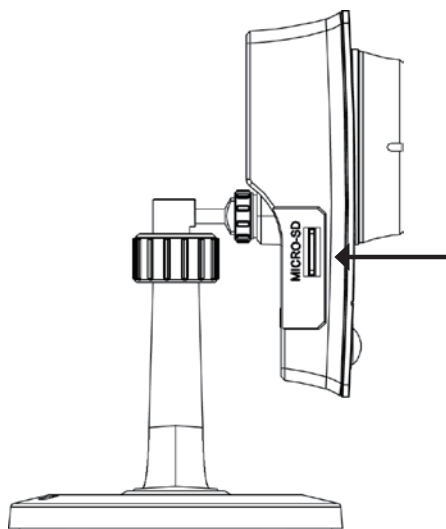

**Bahía para tarjetas
Micro SD**
Almacenamiento local
para guardar imágenes
y vídeos grabados

3. Instalación del hardware

Conexión básica

Conecte la cámara al conmutador o el router mediante un cable Ethernet.
Conecte el cable de alimentación suministrado desde la cámara a una toma de alimentación.

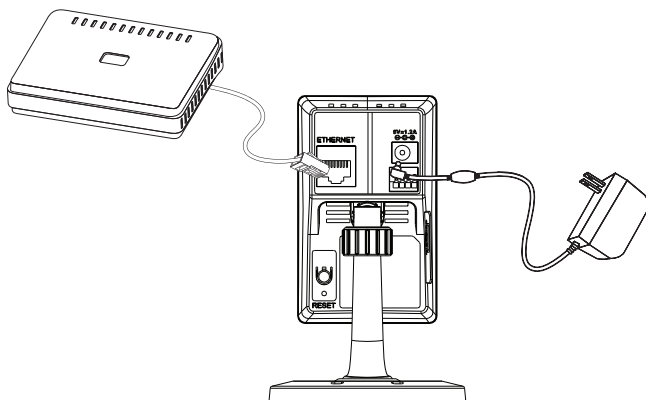

Conexión utilizando un conmutador PoE (DCS-2210 only)

Si utiliza un conmutador PoE o un router, conecte la cámara de red mediante un cable Ethernet.

La PoE transmitirá la alimentación y los datos a través de un solo cable.

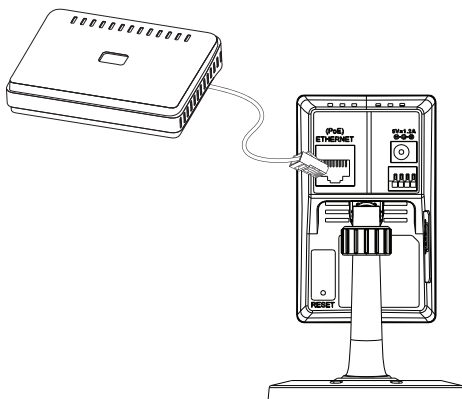

Nota: una vez establecida la alimentación, el LED cambiará a rojo. Cuando el dispositivo obtenga una dirección IP y esté accesible, el LED cambiará a verde.

4. Configuración con el asistente

Inserte el CD de la DCS-2210/DCS-2230 en la unidad de CD-ROM del ordenador para comenzar la instalación. Si la función de ejecución automática del ordenador está desactivada o si el iniciador de D-Link no se inicia automáticamente, haga clic en **Inicio > Ejecutar**. Escriba **D:\autorun.exe**, donde D: representa la letra de unidad de su unidad de CD-ROM.

Haga clic en **Setup Wizard (Asistente para la instalación)** para comenzar la instalación.



Después de hacer clic en el Asistente de configuración, se abrirá la ventana siguiente.

Haga clic en **Next (Siguiente)** para continuar.

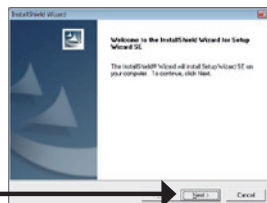

Haga clic en **Yes (Sí)** para aceptar el acuerdo de licencia.

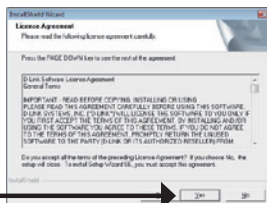

Para iniciar el proceso de instalación, haga clic en **Next (Siguiente)**.

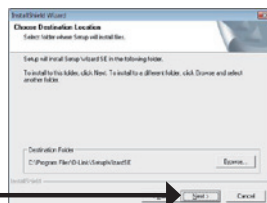

Nota: La instalación puede tardar algunos minutos en finalizar.

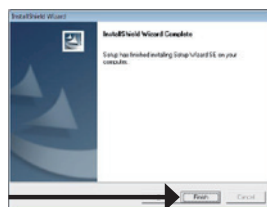

Haga clic en **Finish (Finalizar)** para finalizar la instalación.

Haga clic en el icono **D-Link Setup Wizard SE (Asistente de configuración SE D-Link)** que se creó en el menú de inicio de Windows.

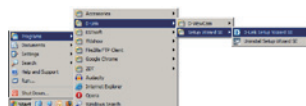

Inicio > D-Link > Setup Wizard SE (Asistente de configuración SE)

Aparecerá el asistente de configuración y mostrará la dirección MAC y la dirección IP de la cámara. Si tiene un servidor DHCP en la red, se mostrará una dirección IP válida. Si la red no utiliza un servidor DHCP, se mostrará la dirección de IP estática predeterminada: **192.168.0.20** de la cámara de red.



Haga clic en el botón **Wizard (Asistente)** para continuar.

Introduzca el ID de administrador y la contraseña. Al iniciar sesión por primera vez, el ID de administrador predeterminado es **admin**, con la contraseña en blanco.

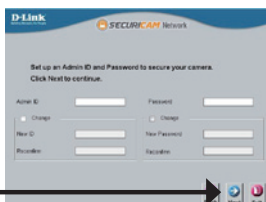

Haga clic en **Next (Siguiente)** para ir a la página siguiente.

Seleccione la opción **DHCP** si la cámara obtiene automáticamente una dirección IP al reiniciarse. Seleccione la opción **Static IP (IP estática)** si la cámara utilizará la misma dirección IP cada vez que se inicia.



Haga clic en **Next (Siguiente)** para ir a la página siguiente.



Tómese un tiempo para confirmar la configuración y haga clic en **Restart (Reiniciar)**.

Visualización de la cámara a través del explorador de web

Haga clic en el icono **D-Link Setup Wizard SE (Asistente de configuración SE D-Link)** que se creó en el menú de inicio de Windows.

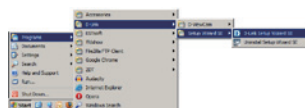

Inicio > D-Link > Setup Wizard SE (Asistente de configuración SE)

Seleccione la cámara y haga clic en el botón con la etiqueta "**Link (Vínculo)**" para acceder a la configuración web.



El asistente de configuración abrirá automáticamente el explorador de web en la dirección IP de la cámara.



Escriba **admin** como nombre de usuario predeterminado y deje la contraseña en blanco. Haga clic en **OK (Aceptar)** para continuar.

Esta sección muestra el vídeo en directo de la cámara. Puede seleccionar el perfil de vídeo y ver o utilizar la cámara. Para obtener información adicional acerca de la configuración de web, consulte el manual de usuario incluido en el CD-ROM o el sitio web de D-Link.



Asistencia técnica

<http://www.dlink.es>

Asistencia Técnica Telefónica de D-Link: +34 902 30 45 45 0,067 €/min

De Lunes a Viernes de 9:00 a 19:00

Guida di installazione rapida di DCS-2210/DCS-2230

In questa guida di installazione sono riportate le istruzioni di base per installare la videocamera DCS-2210/DCS-2230 Network Camera in rete. Per ulteriori informazioni sull'utilizzo della videocamera, consultare il manuale utente disponibile sul CD incluso nella confezione o scaricabile dal sito Web di supporto di D-Link.

Procedura di installazione

1. Verificare il contenuto della confezione in base all'elenco seguente.
2. Panoramica hardware
3. Installazione hardware
4. Procedura guidata di configurazione

1. Contenuto della confezione

- DCS-2210/DCS-2230 Network Camera
- Base per la videocamera
- Manuale e software su CD-ROM
- Cavo Ethernet CAT5
- Alimentatore
- Guida di installazione rapida

Se uno o più degli articoli sopra elencati risultano mancanti, rivolgersi al rivenditore.

2. Panoramica hardware

Pannello posteriore

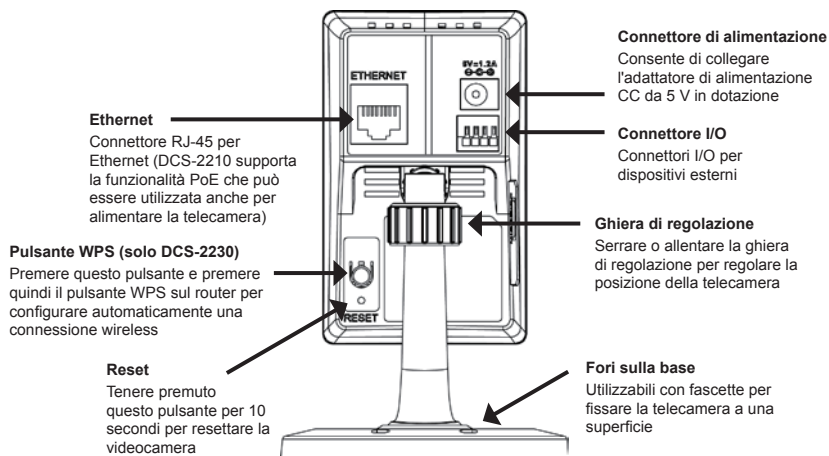

Pannello frontale

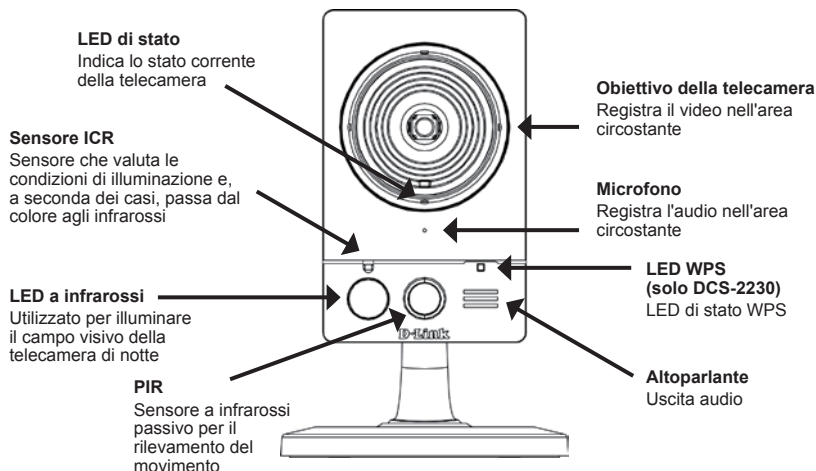

Pannello di sinistra

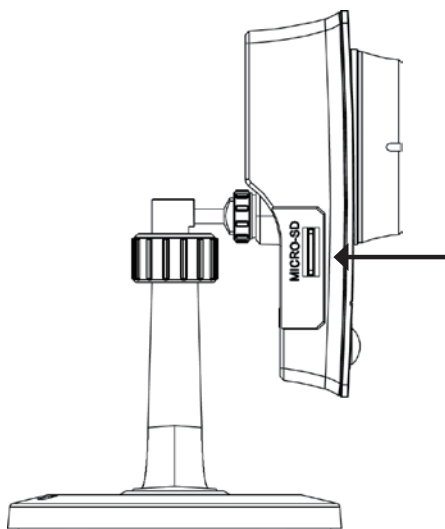

Slot per schede Micro SD
Slot per l'archiviazione
locale di immagini e video
registrati

3. Installazione dell'hardware

Collegamento di base

Collegare la videocamera allo switch o al router tramite il cavo Ethernet.
Collegare un'estremità del cavo di alimentazione fornito alla videocamera e l'altra estremità a una presa elettrica.

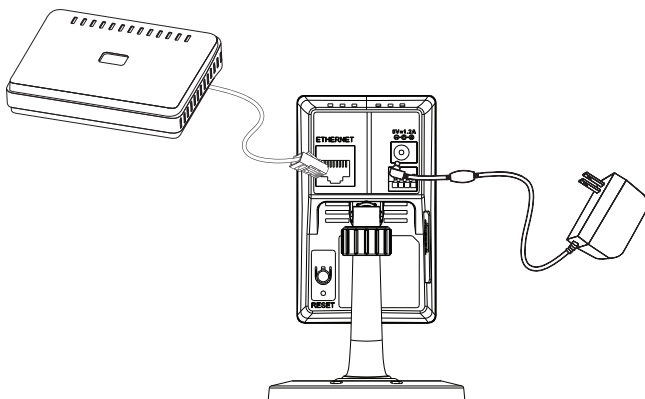

Collegamento tramite switch PoE (DCS-2210 only)

Se si utilizza uno switch o un router PoE, collegare la videocamera di rete tramite il cavo Ethernet.

PoE utilizzerà un solo cavo sia per l'alimentazione che per la trasmissione dei dati.

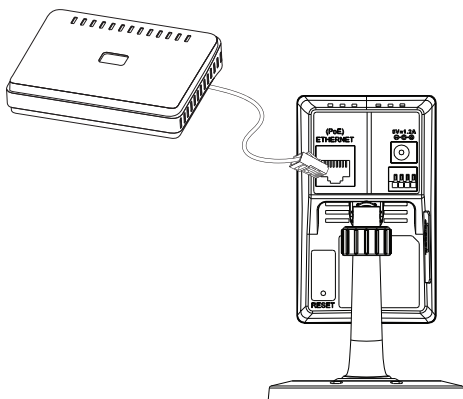

Nota: se la videocamera è alimentata, il LED diventa di colore rosso. Dopo che la videocamera ha ottenuto un indirizzo IP e risulta accessibile, il LED diventa di colore verde.

4. Procedura guidata di configurazione

Inserire il CD di DCS-2210/DCS-2230 nell'unità CD-ROM del computer per avviare l'installazione. Se la funzione di esecuzione automatica è disabilitata nel computer in uso o se l'utilità di avvio di D-Link non viene avviata automaticamente, fare clic su **Start > Run** (Start > Esegui). Digitare **D:\autorun.exe**, dove D: rappresenta la lettera dell'unità CD-ROM.

Fare clic su **Setup Wizard** (Installazione guidata) per avviare l'installazione.



Dopo aver fatto clic sul comando dell'installazione guidata, verrà aperta la seguente finestra.

Fare clic su **Next** (Avanti) per continuare.

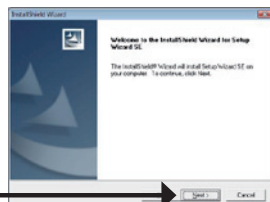

Fare clic su **Yes** (Sì) per accettare il contratto di Licenza.

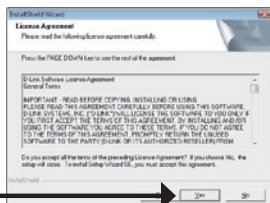

Per avviare il processo di installazione, fare clic su **Next** (Avanti).

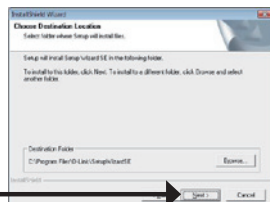

Nota: il completamento dell'installazione può richiedere alcuni minuti.

Fare clic su **Finish** (Fine) per completare l'installazione.

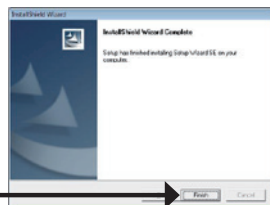

Fare clic sull'icona **D-Link Setup Wizard SE** creata nel menu di Start di Windows.

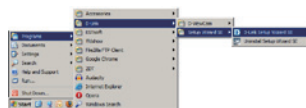

Start > D-Link > Setup Wizard SE

Nella pagina dell'Installazione guidata verranno visualizzati l'indirizzo MAC e l'indirizzo IP della videocamera. Se la rete dispone di un server DHCP, viene visualizzato un indirizzo IP valido. Se la rete non dispone di un server DHCP, verrà visualizzato l'indirizzo IP statico predefinito della videocamera di rete, ovvero **192.168.0.20**.

Fare clic su **Wizard** (Installazione guidata) per continuare.



Inserire l'ID e la password dell'amministratore. Quando si effettua l'accesso per la prima volta, l'ID predefinito dell'amministratore è **admin**, mentre la password viene lasciata vuota.

Fare clic su **Next** (Avanti) per passare alla pagina successiva.

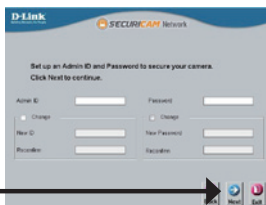

Selezionare l'opzione **DHCP** se la videocamera in uso ottiene automaticamente un indirizzo IP all'avvio. Selezionare l'opzione **Static IP** (IP statico) se la videocamera utilizzerà lo stesso indirizzo IP ogni volta che viene avviato.

Fare clic su **Next** (Avanti) per passare alla pagina successiva.



Verificare le impostazioni, quindi fare clic su **Restart** (Riavvia).



Visualizzazione della videocamera tramite il browser Web

Fare clic sull'icona **D-Link Setup Wizard SE** creata nel menu di Start di Windows.

Start > D-Link > Setup Wizard SE

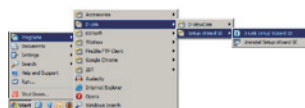

Selezionare la videocamera e fare clic sul pulsante "**Link**" (Collegamento) per accedere alla configurazione Web.



La procedura guidata di configurazione apre automaticamente il browser Web all'indirizzo IP della videocamera.

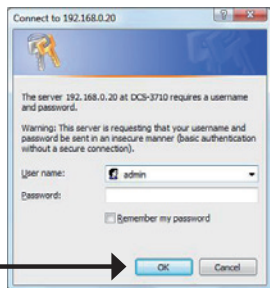

Immettere **admin** come nome utente predefinito e lasciare il campo password vuoto. Fare clic su **OK** per continuare.

Questa sezione descrive il video in diretta della videocamera. È possibile selezionare il profilo video desiderato e visualizzare le immagini o mettere in funzione la videocamera. Per ulteriori informazioni sulla configurazione Web, fare riferimento al manuale utente incluso sul CD-ROM o scaricabile dal sito Web di D-Link.



Supporto tecnico

<http://www.dlink.it/support>

Supporto Tecnico dal lunedì al venerdì dalle ore 9.00 alle ore 19.00 con orario continuato

Telefono: 199400057

D-Link®



Ver. 1.00(EU)
2011/07/04
RMN0100710